

BASE 900

Designed by Zuzana Licko in 2010.

The lineage of Base 900 is an example of how technological restraints can serve as a source for design inspiration and exploration. The design of Base 900 morphed from a bitmap to a restricted outline, to a full, high resolution typeface. The resulting Base 900 fonts still convey a modular, geometric style, reminiscent of the early computer technology era, but with an updated, more refined look made possible by a high resolution grid.

For more information, see:
<<https://www.emigre.com/Fonts/Base-900>>

More Digital Font Sketches:
<<https://www.emigre.com/DigitalFontSketches>>

BASE 900

.....
Base900Sans L | exclam | RoboFog Sketches | 2010 | Emigre Fonts

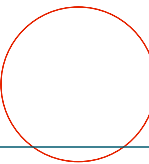
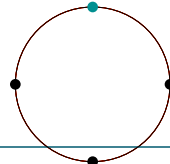
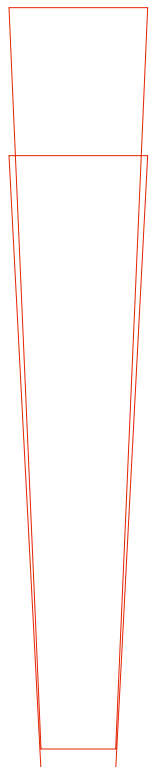
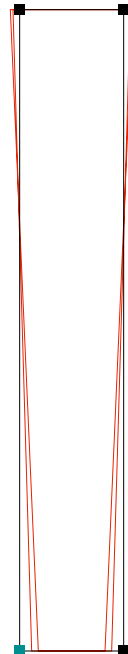

BASE 900

.....
Base900Sans L | ampersand | RoboFog Sketches | 2010 | Emigre Fonts

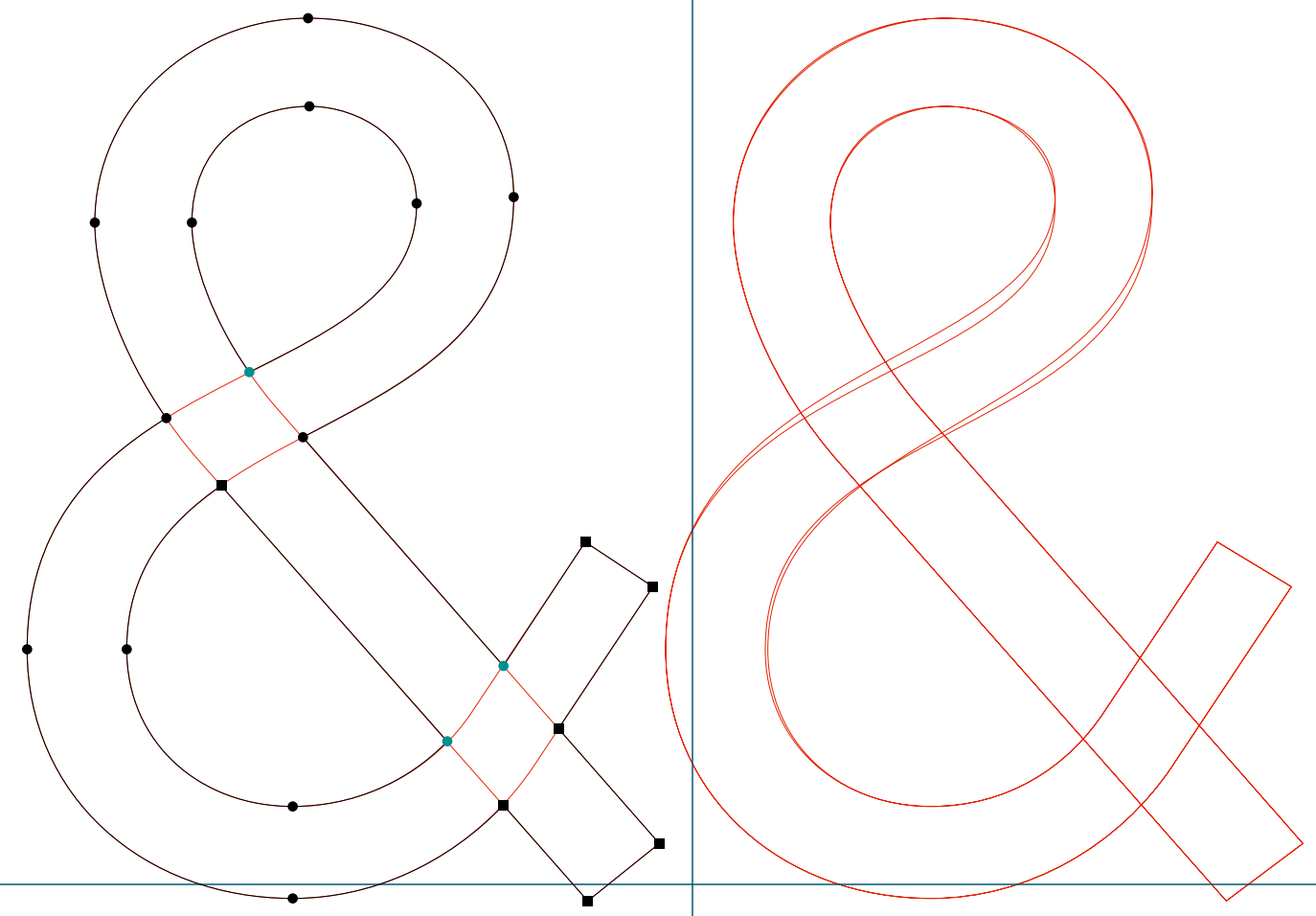

BASE 900

Base900Sans L | asterisk | RoboFog Sketches | 2010 | Emigre Fonts

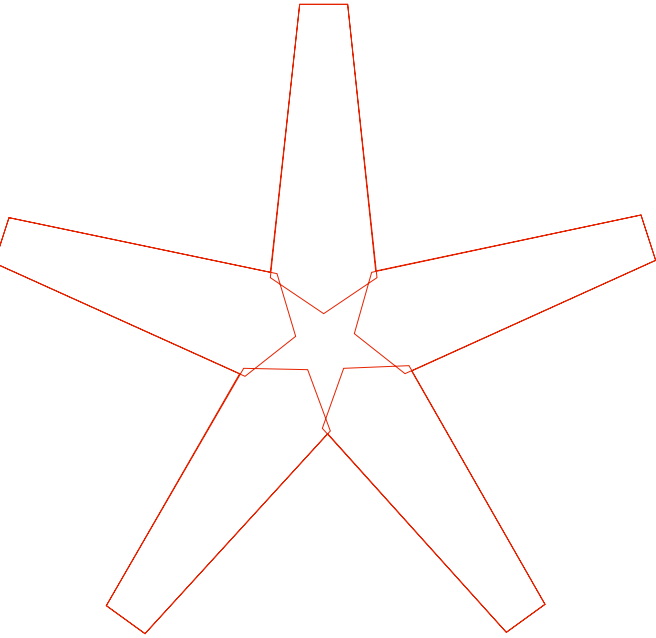
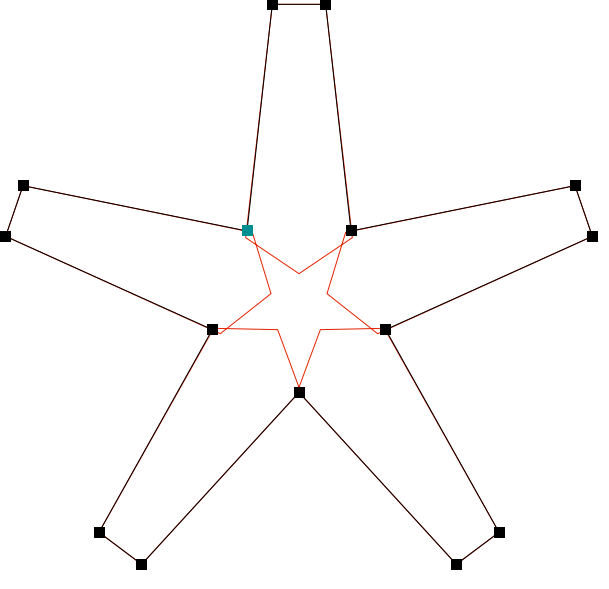
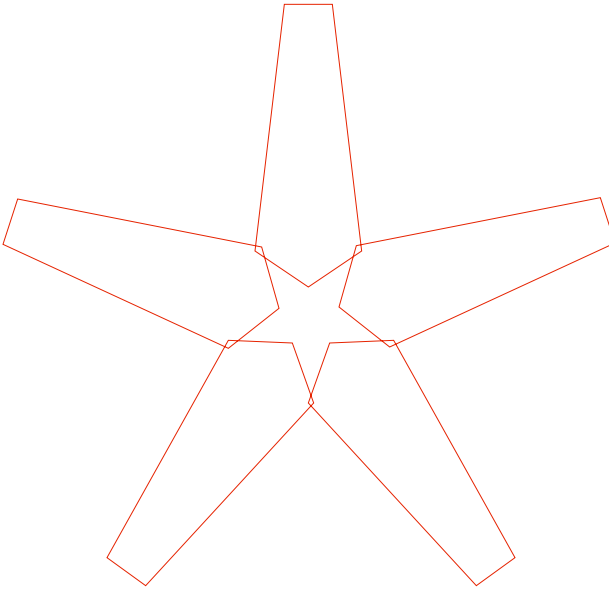

BASE 900

.....
Base900Sans L | period | RoboFog Sketches | 2010 | Emigre Fonts

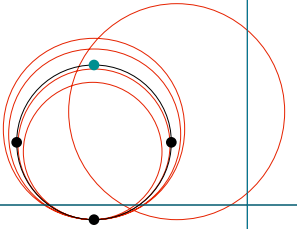

BASE 900

Base900Sans L | zero | RoboFog Sketches | 2010 | Emigre Fonts

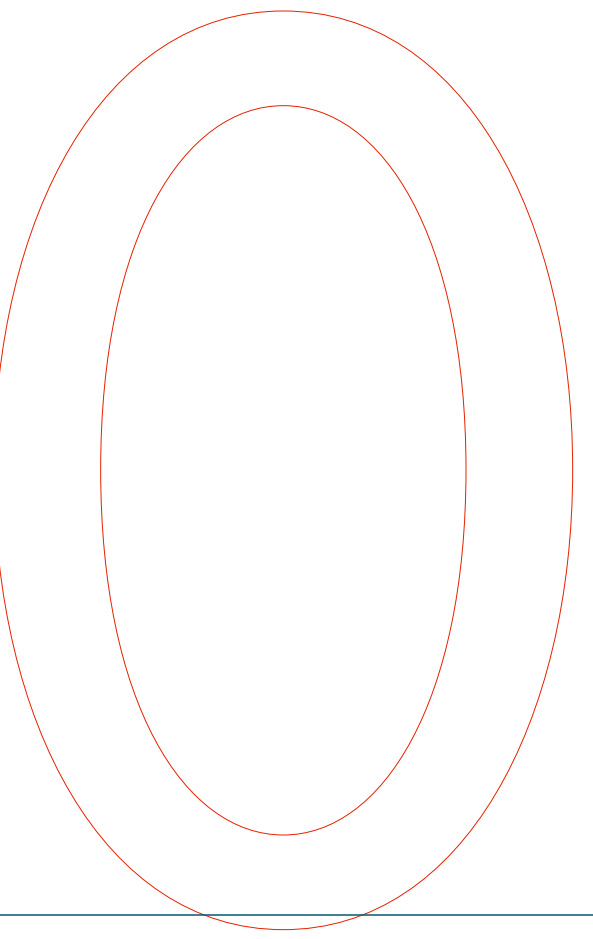
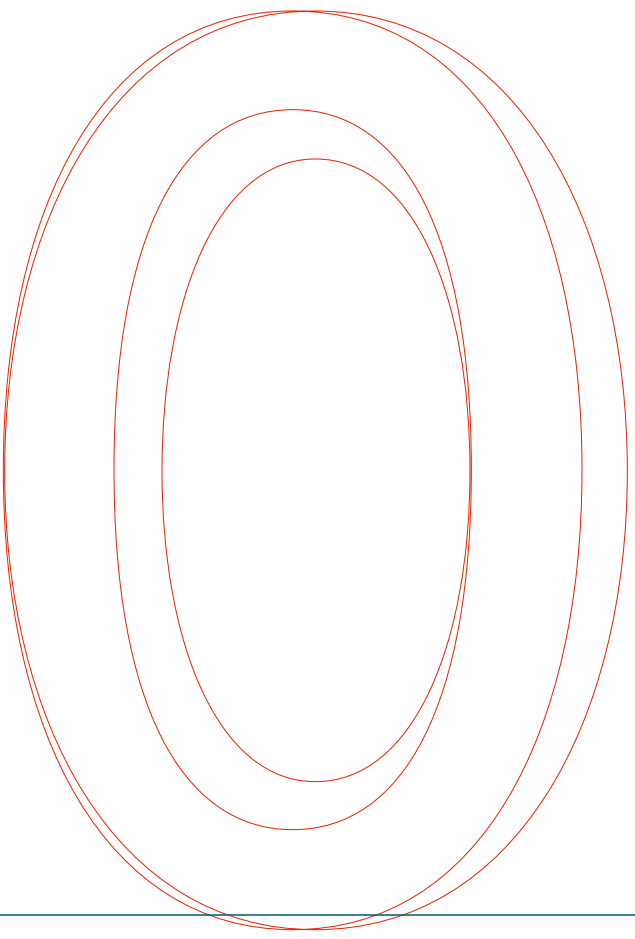
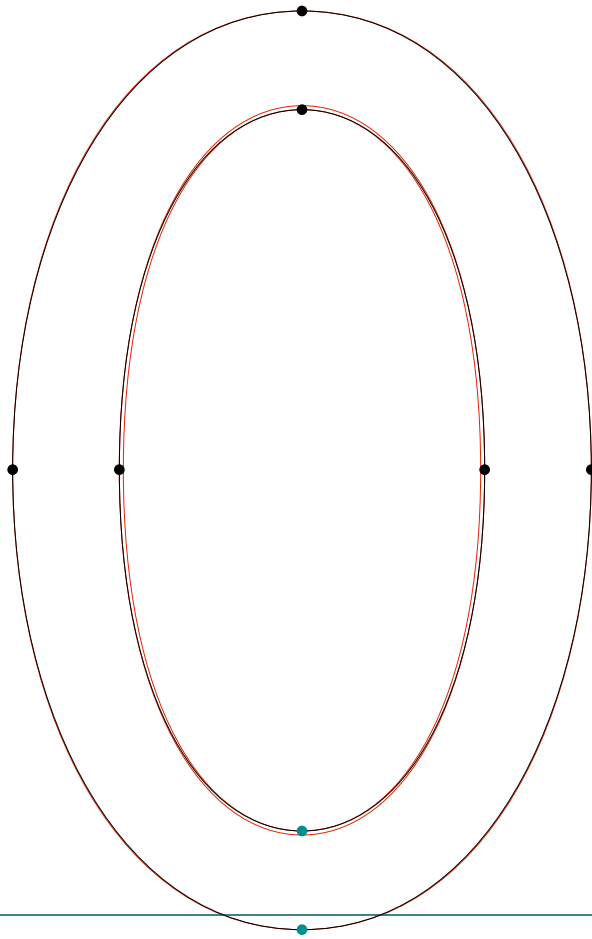

BASE 900

Base900Sans L | one | RoboFog Sketches | 2010 | Emigre Fonts

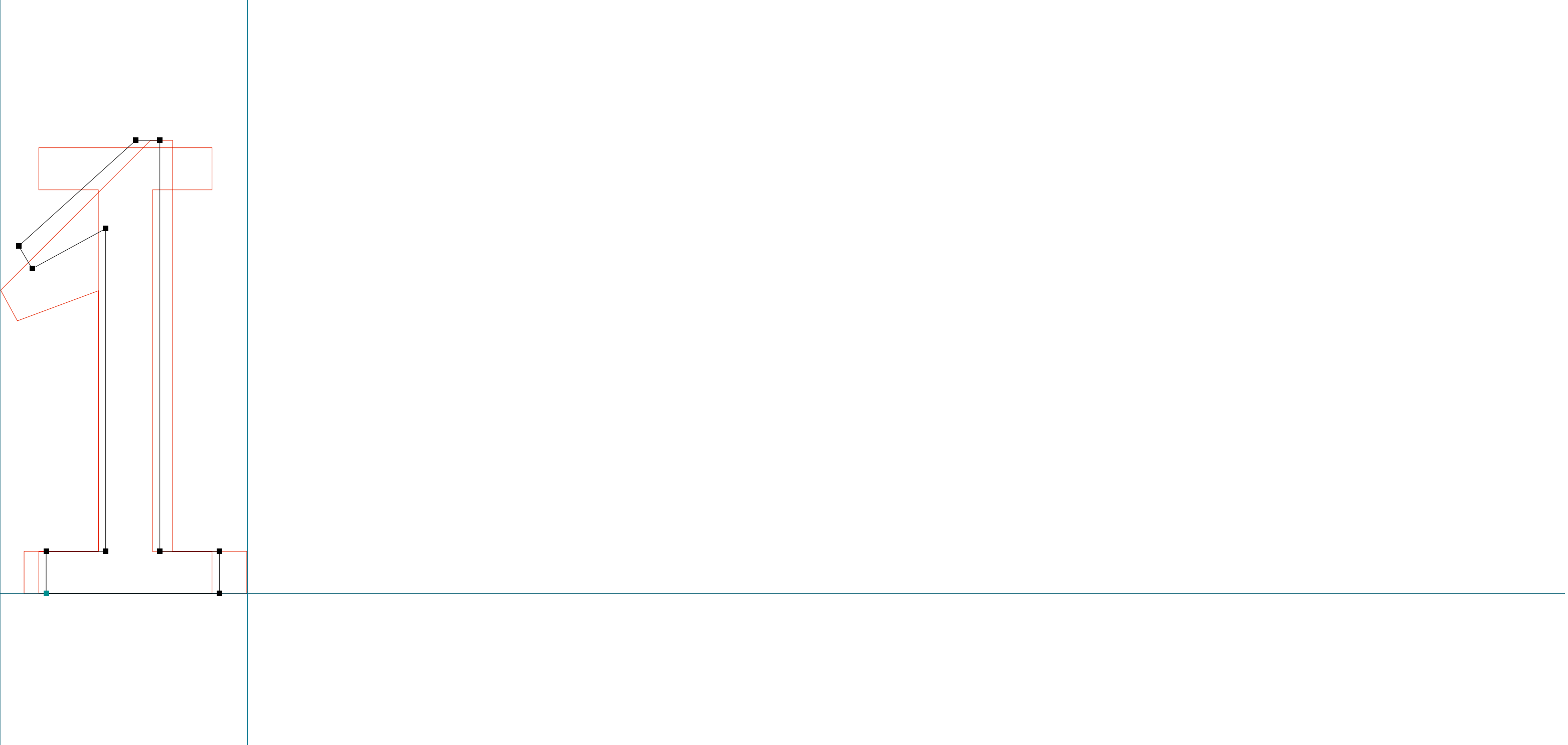

BASE 900

.....
Base900Sans L | two | RoboFog Sketches | 2010 | Emigre Fonts

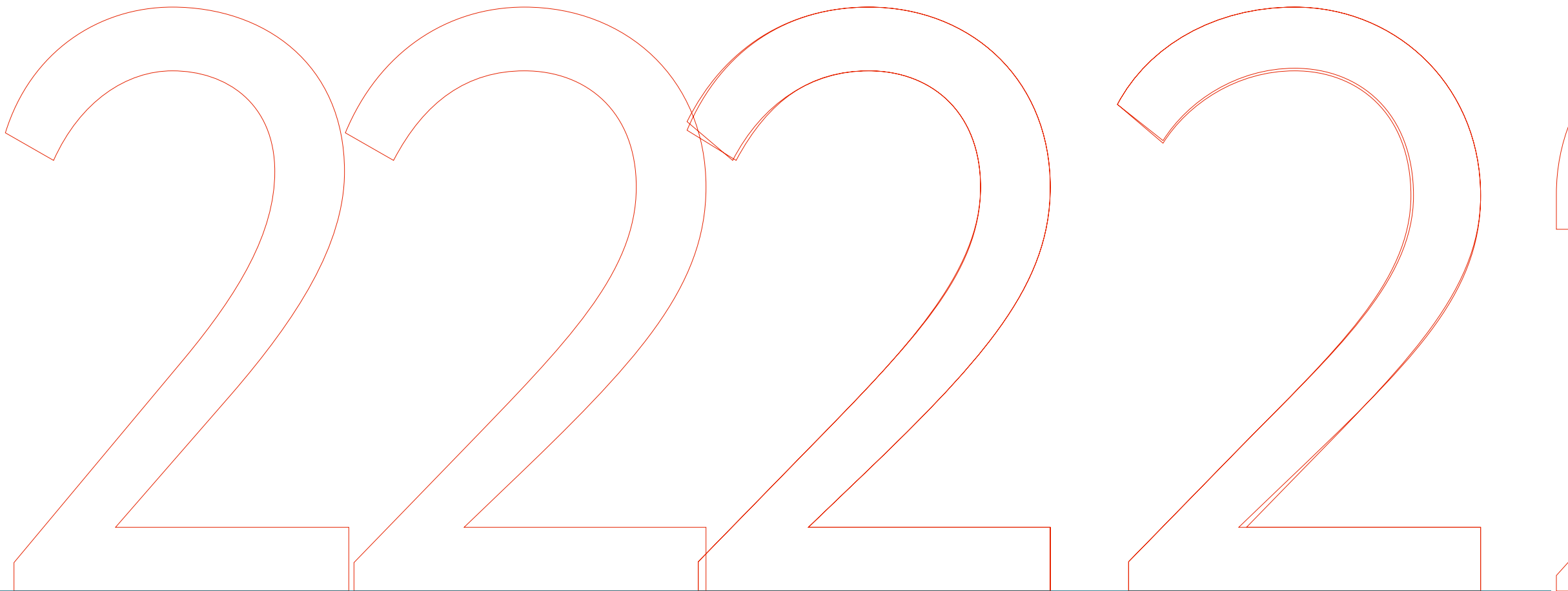
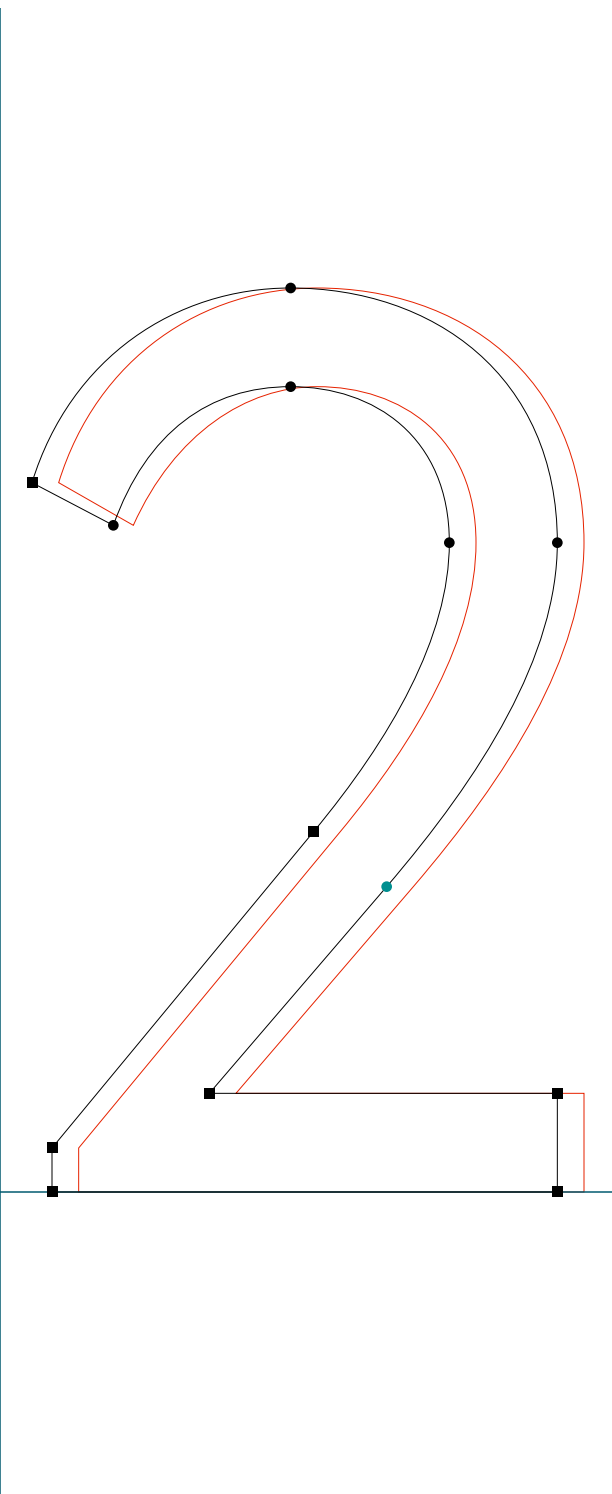

BASE 900

Base900Sans L | three | RoboFog Sketches | 2010 | Emigre Fonts

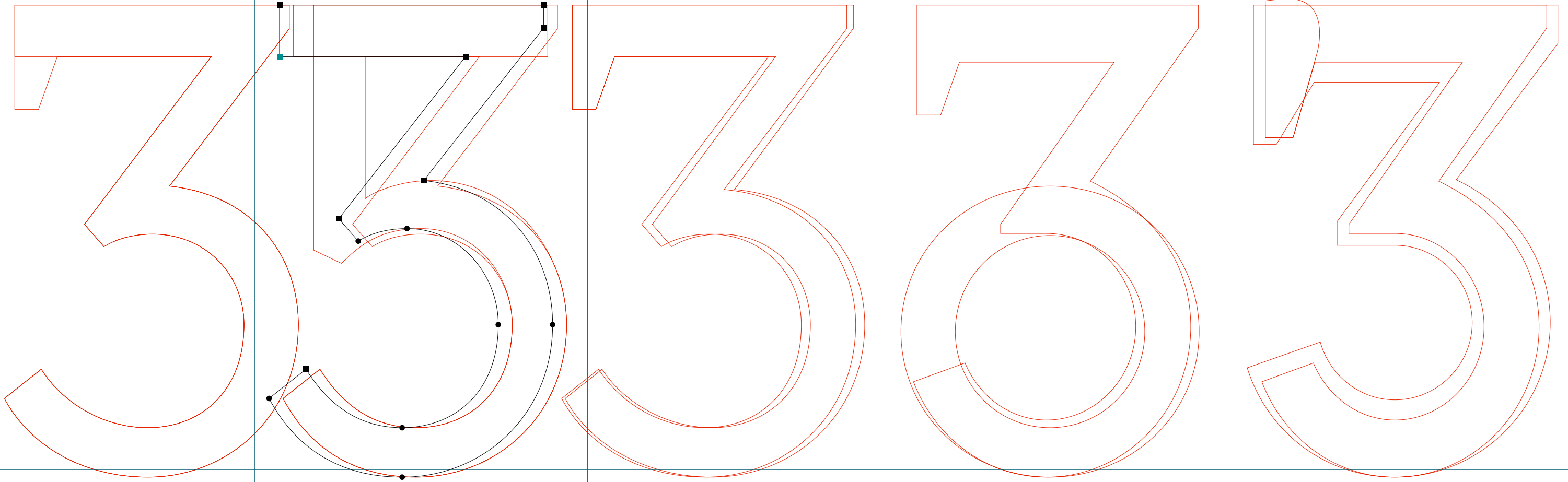

BASE 900

.....
Base900Sans L | five | RoboFog Sketches | 2010 | Emigre Fonts

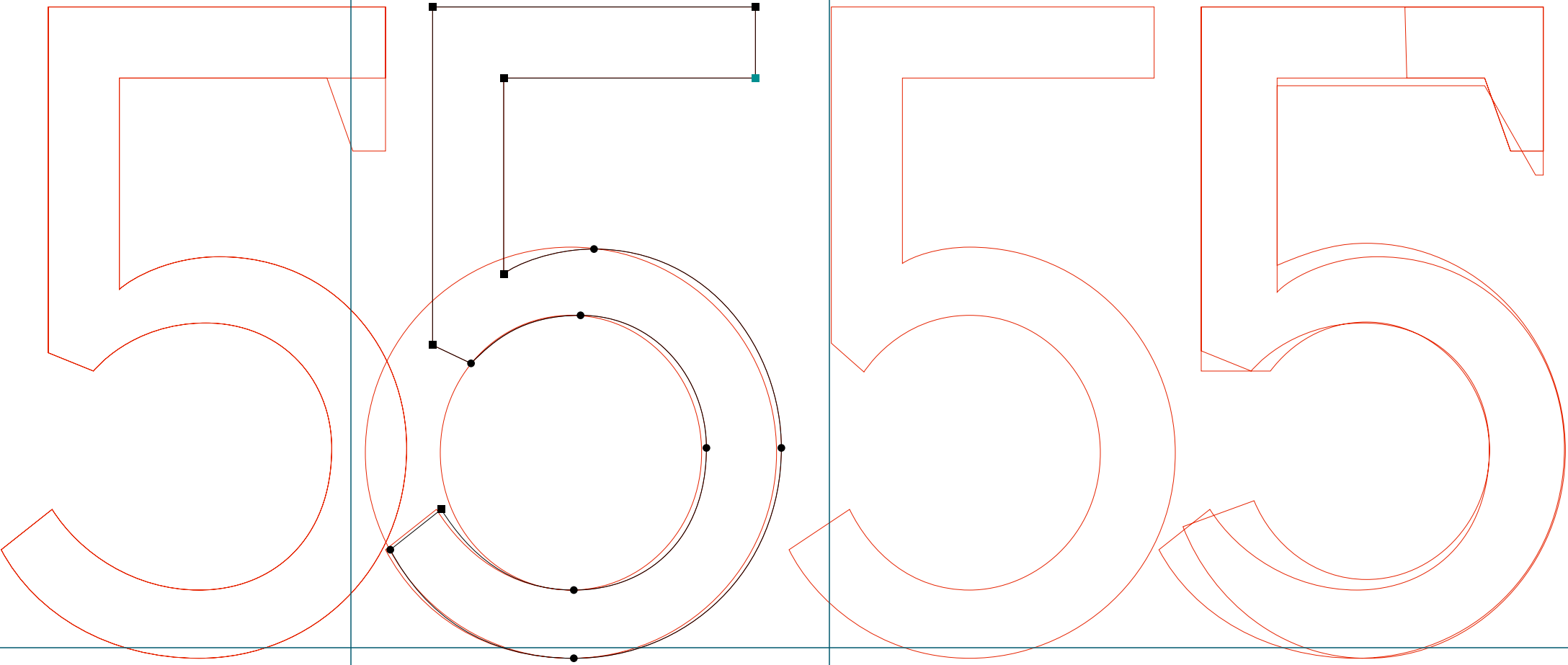

BASE 900

.....
Base900Sans L | six | RoboFog Sketches | 2010 | Emigre Fonts

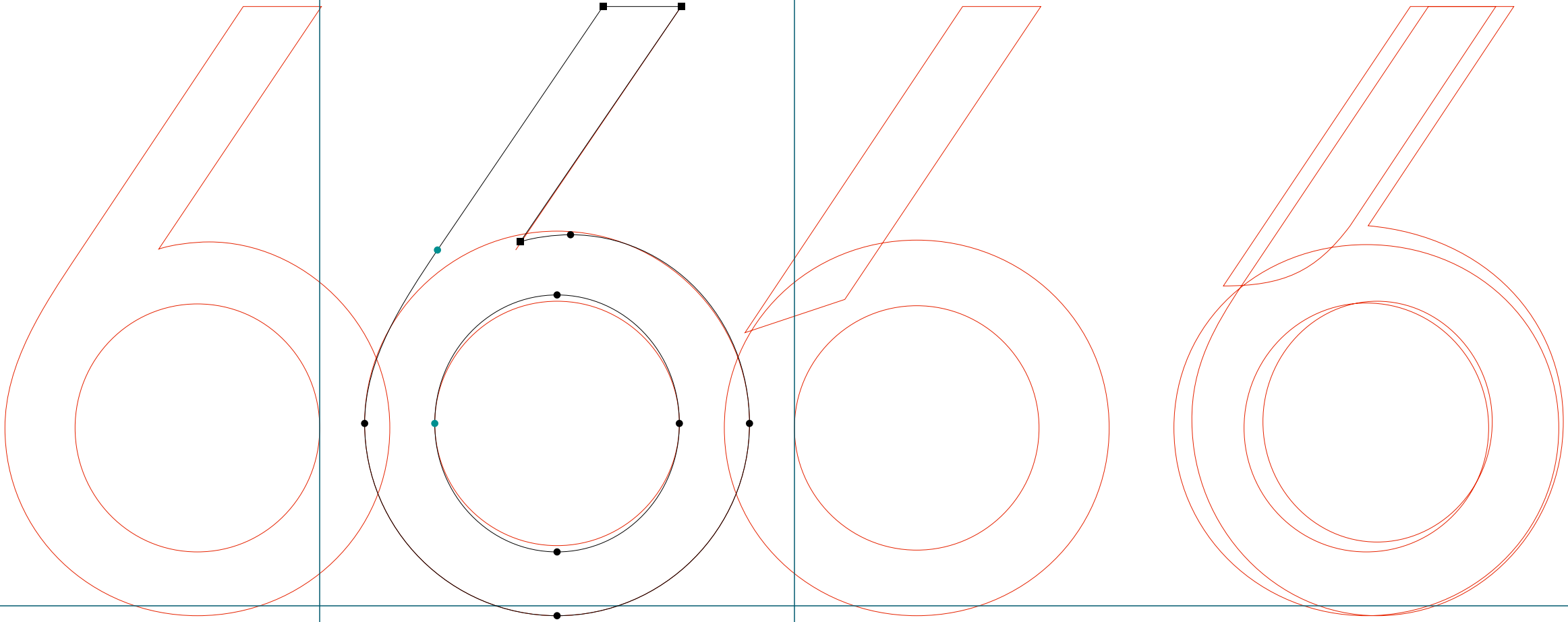

BASE 900

Base900Sans L | seven | RoboFog Sketches | 2010 | Emigre Fonts

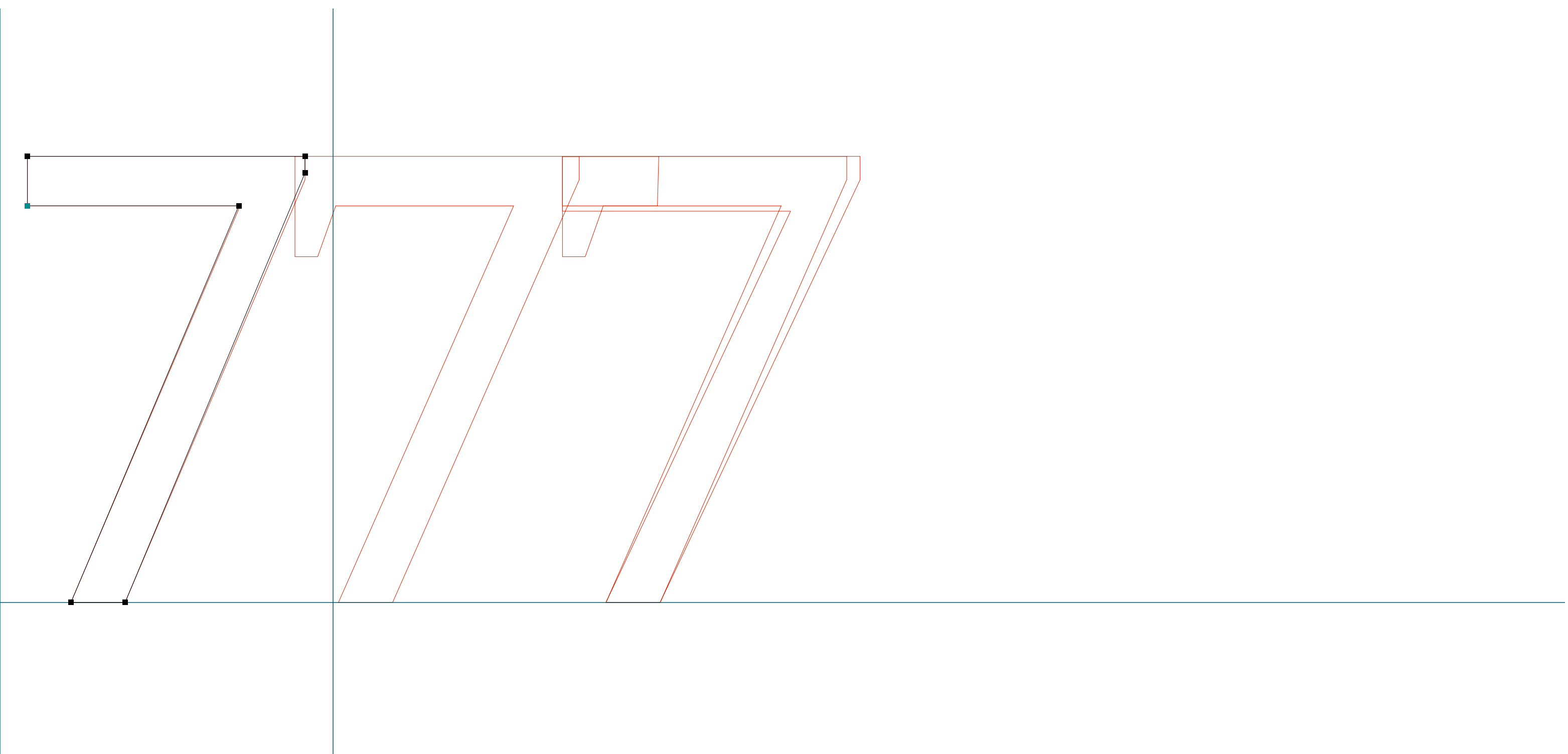

BASE 900

.....
Base900Sans L | eight | RoboFog Sketches | 2010 | Emigre Fonts

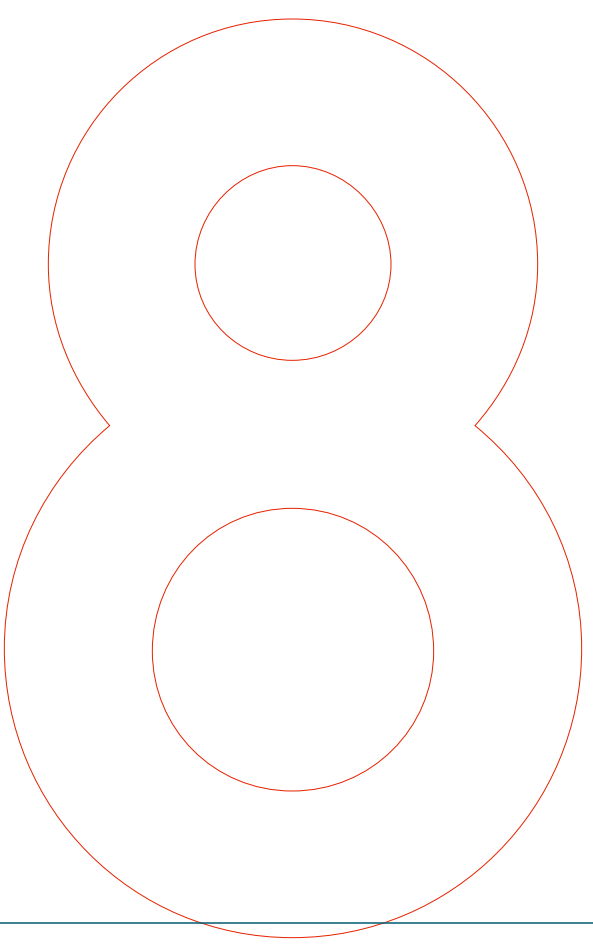
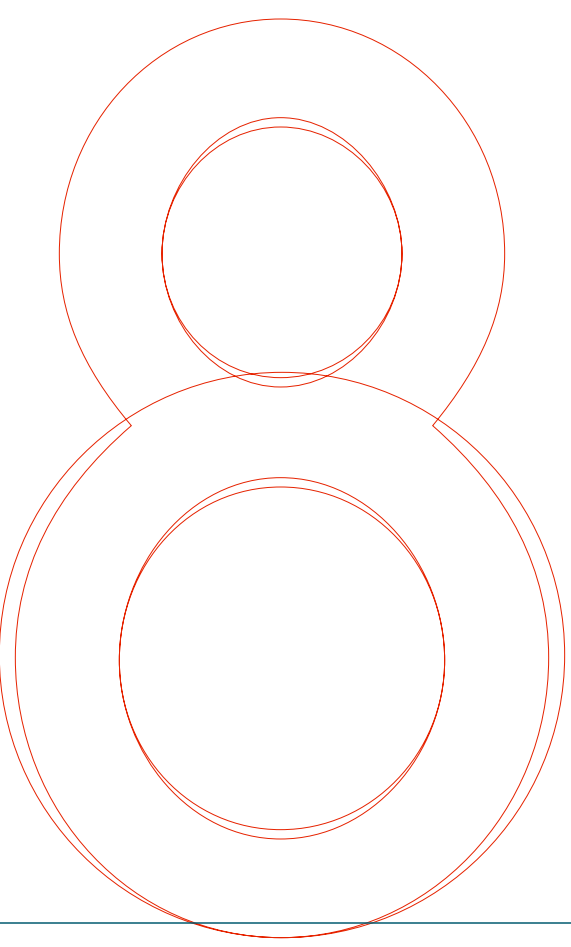
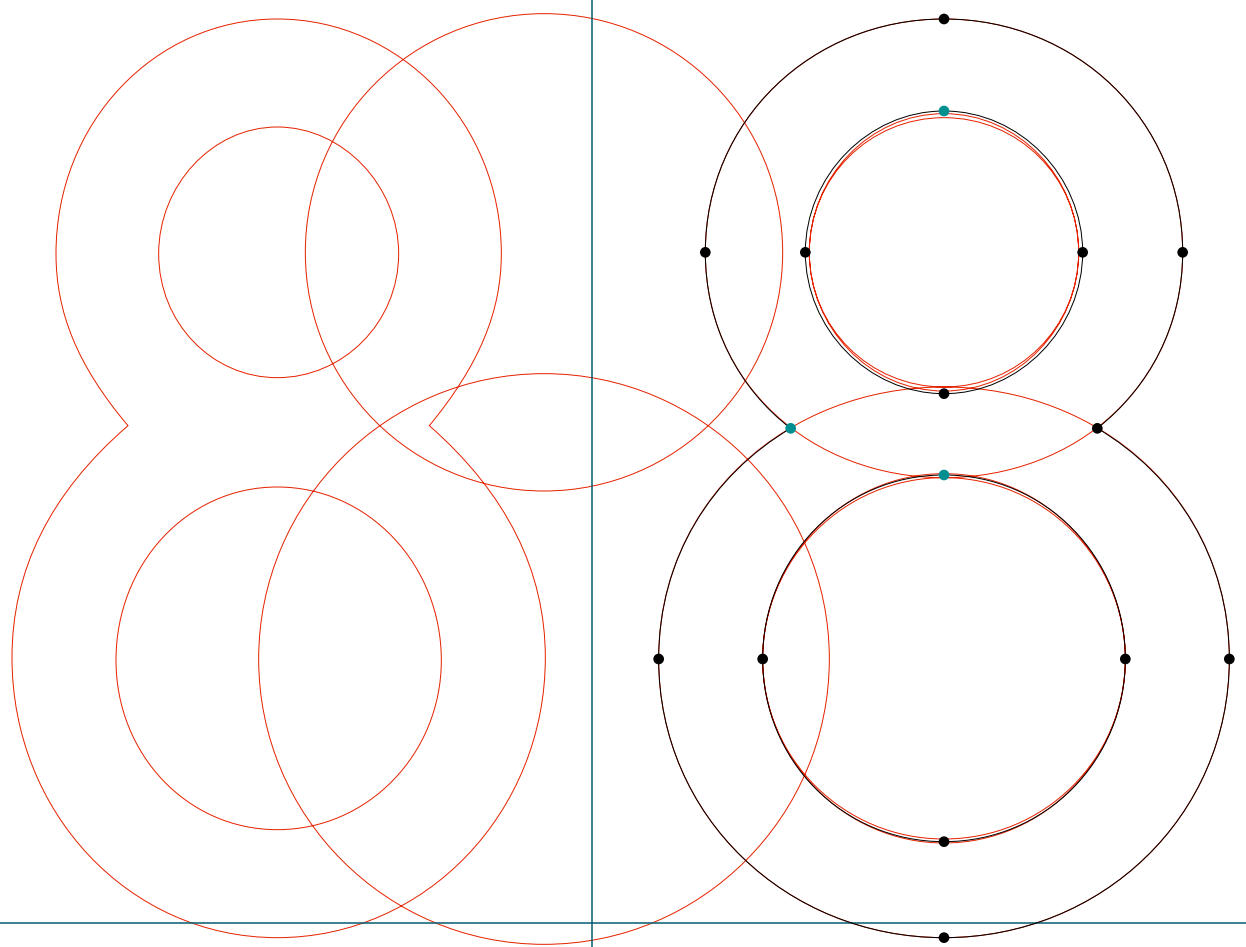

BASE 900

Base900Sans L | semicolon | RoboFog Sketches | 2010 | Emigre Fonts

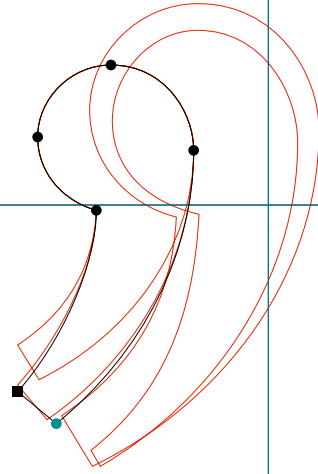
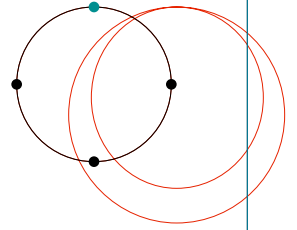

BASE 900

Base900Sans L | question | RoboFog Sketches | 2010 | Emigre Fonts

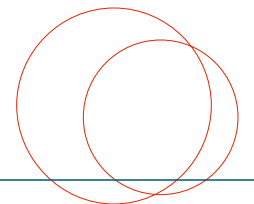
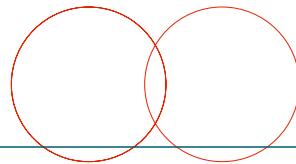
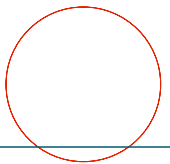
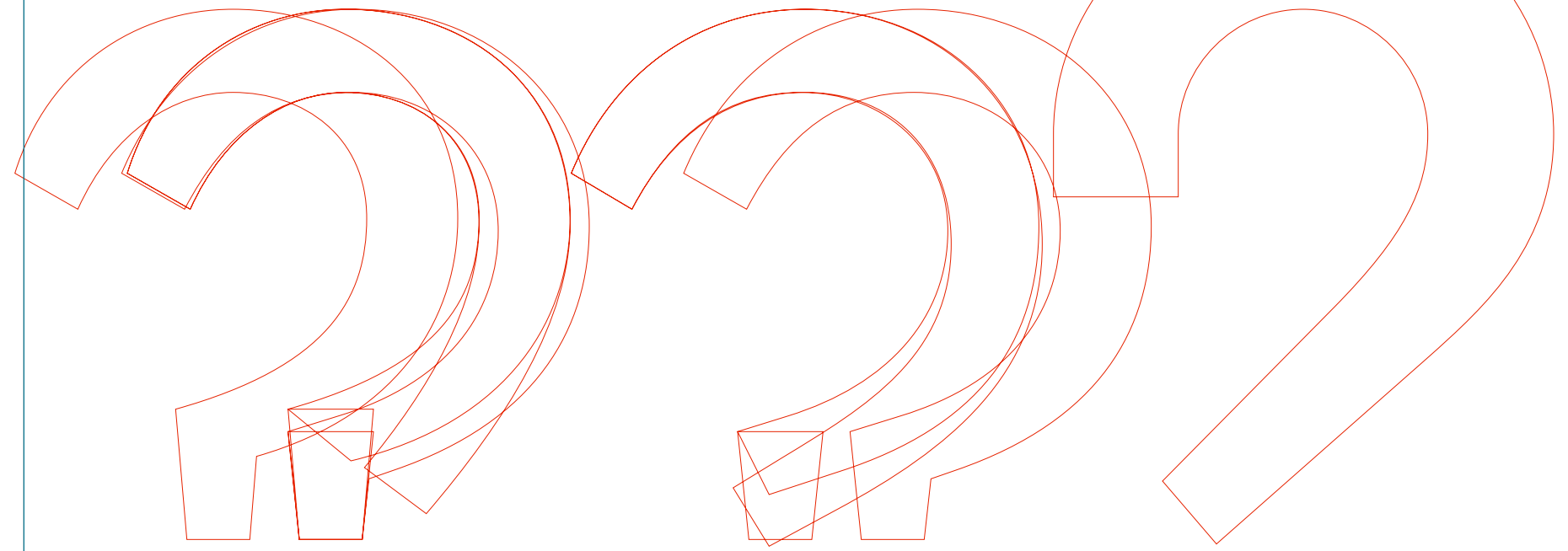
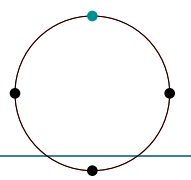
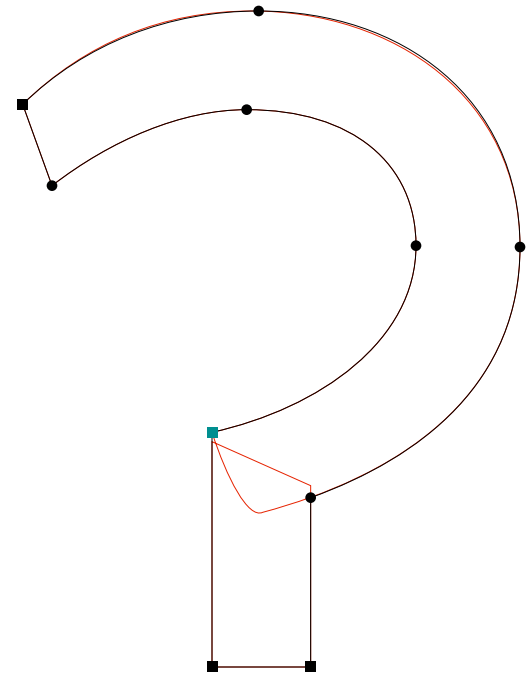
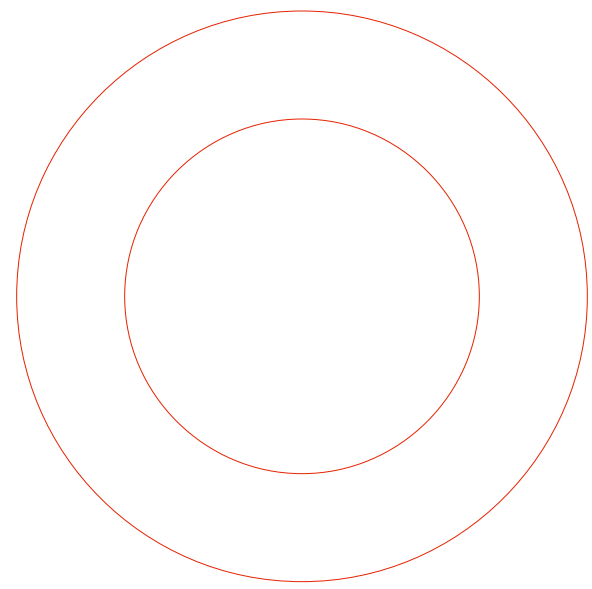

BASE 900

Base900Sans L | at | RoboFog Sketches | 2010 | Emigre Fonts

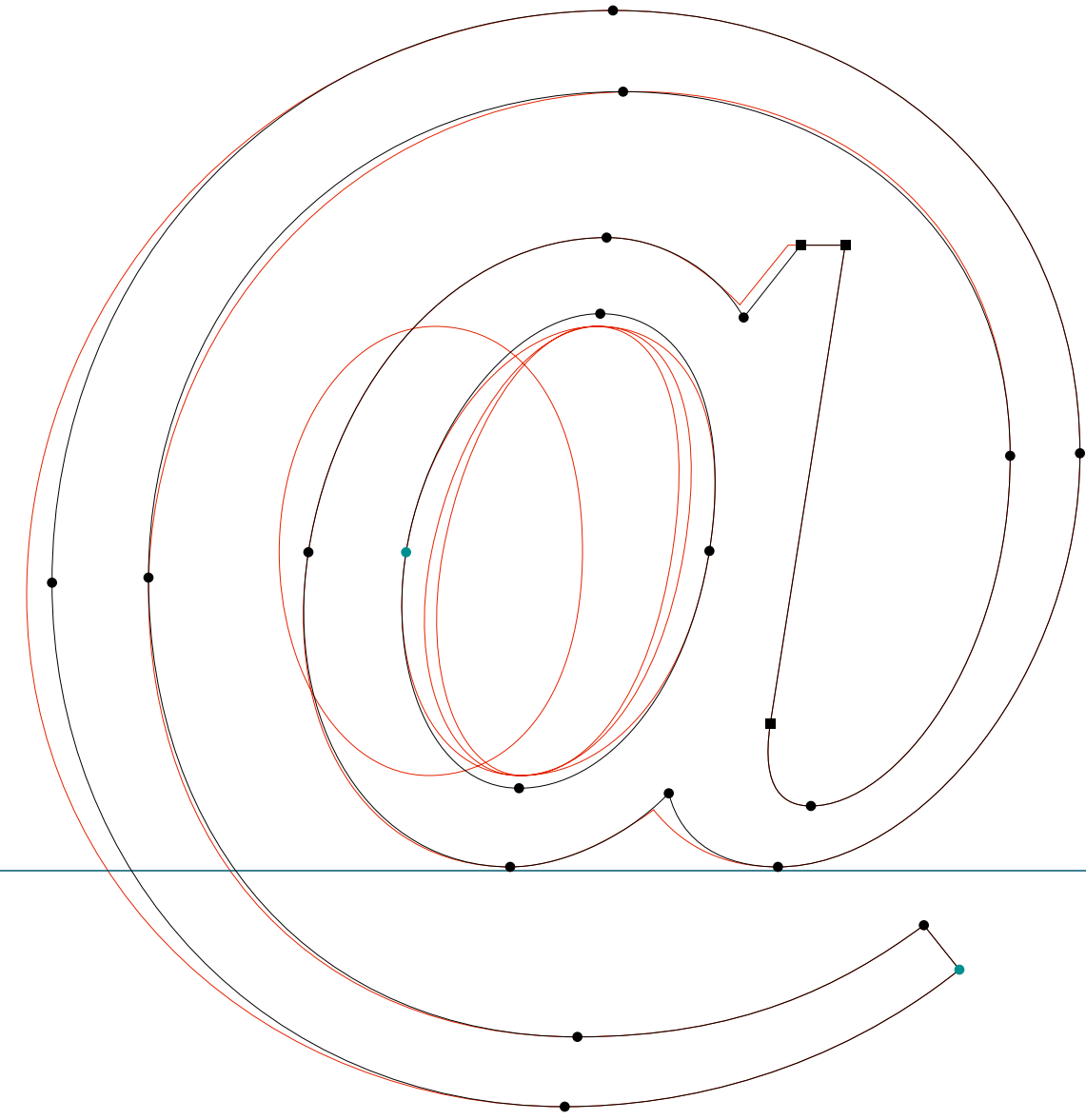
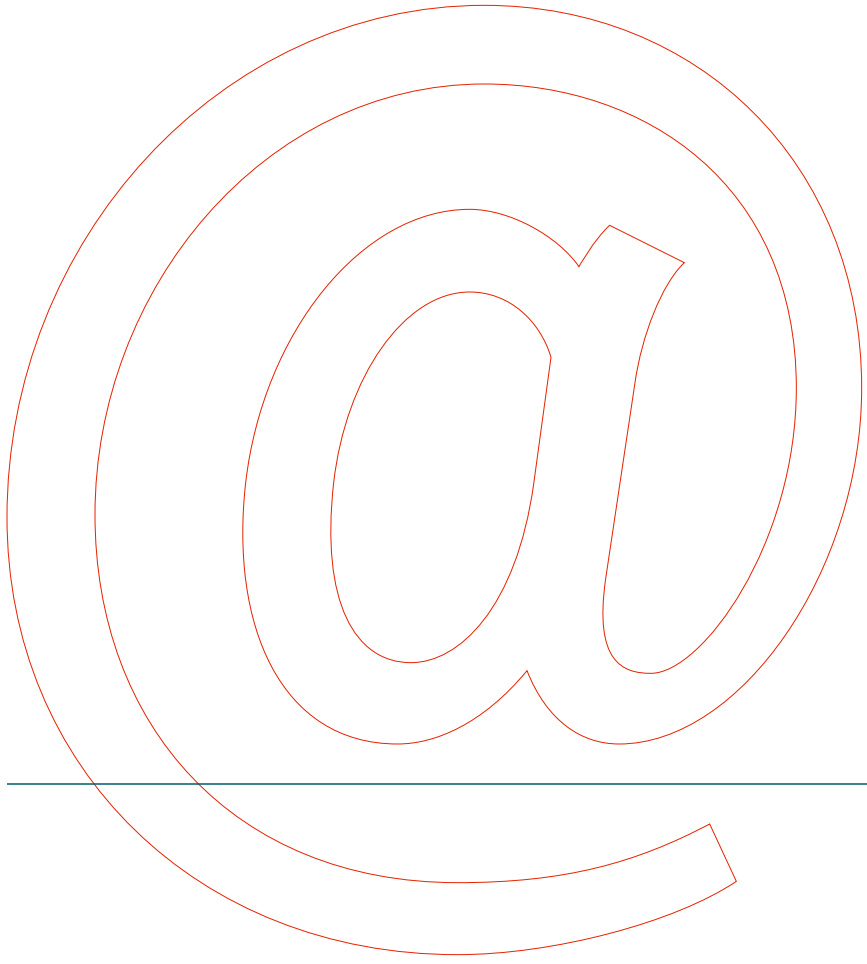

BASE 900

Base900Sans L | G | RoboFog Sketches | 2010 | Emigre Fonts

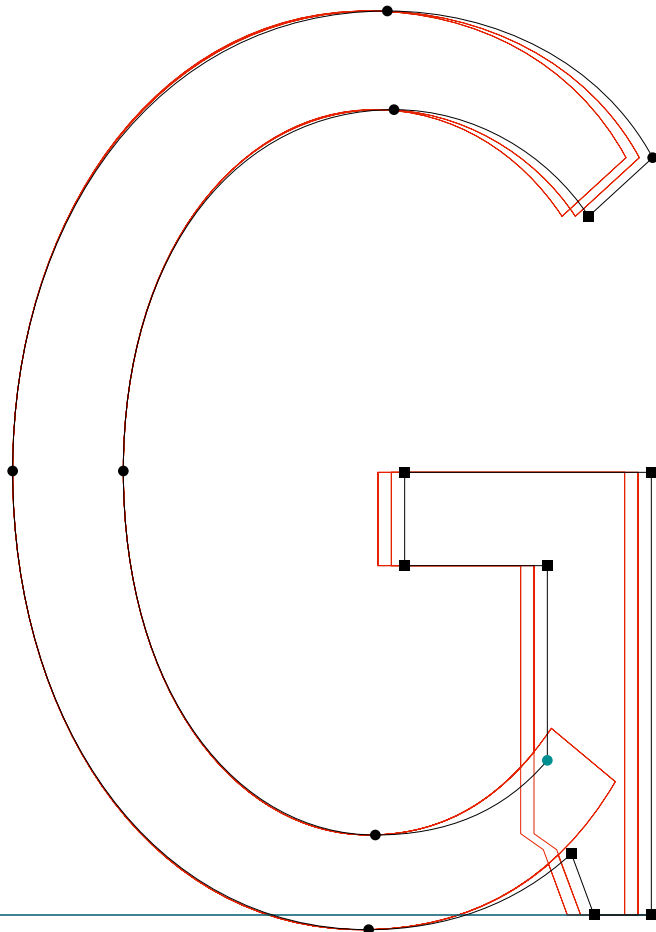

BASE 900

.....
Base900Sans L | J | RoboFog Sketches | 2010 | Emigre Fonts

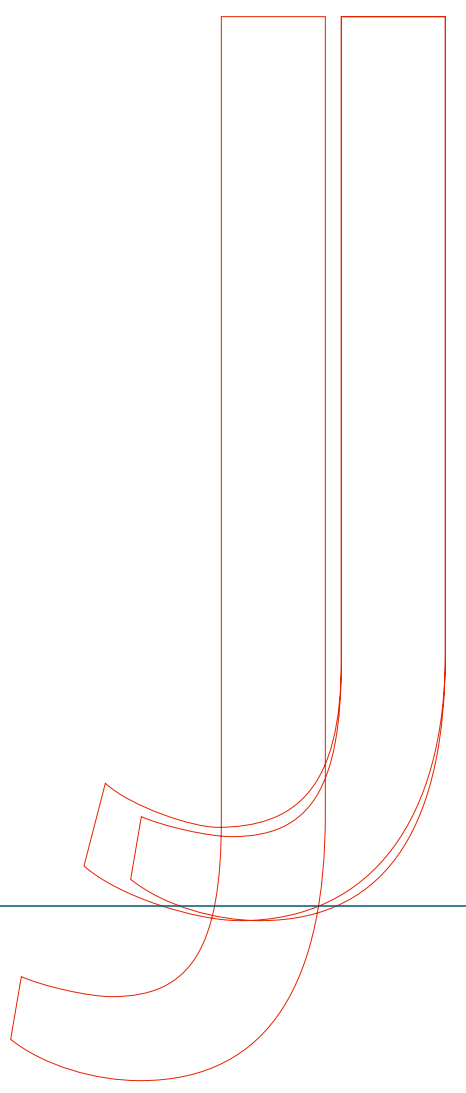
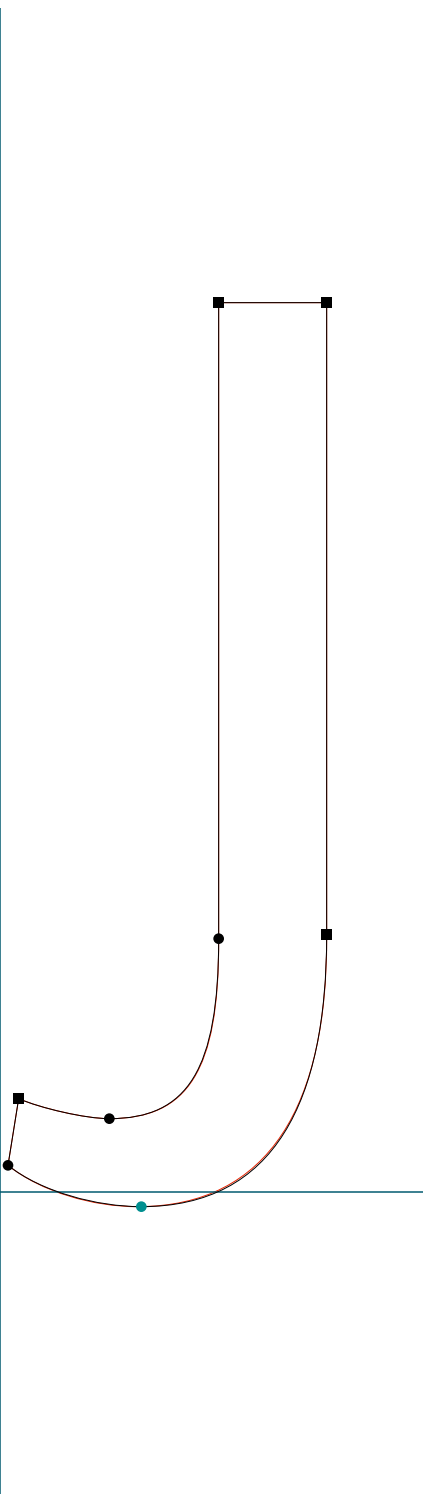

BASE 900

.....
Base900Sans L | O | RoboFog Sketches | 2010 | Emigre Fonts

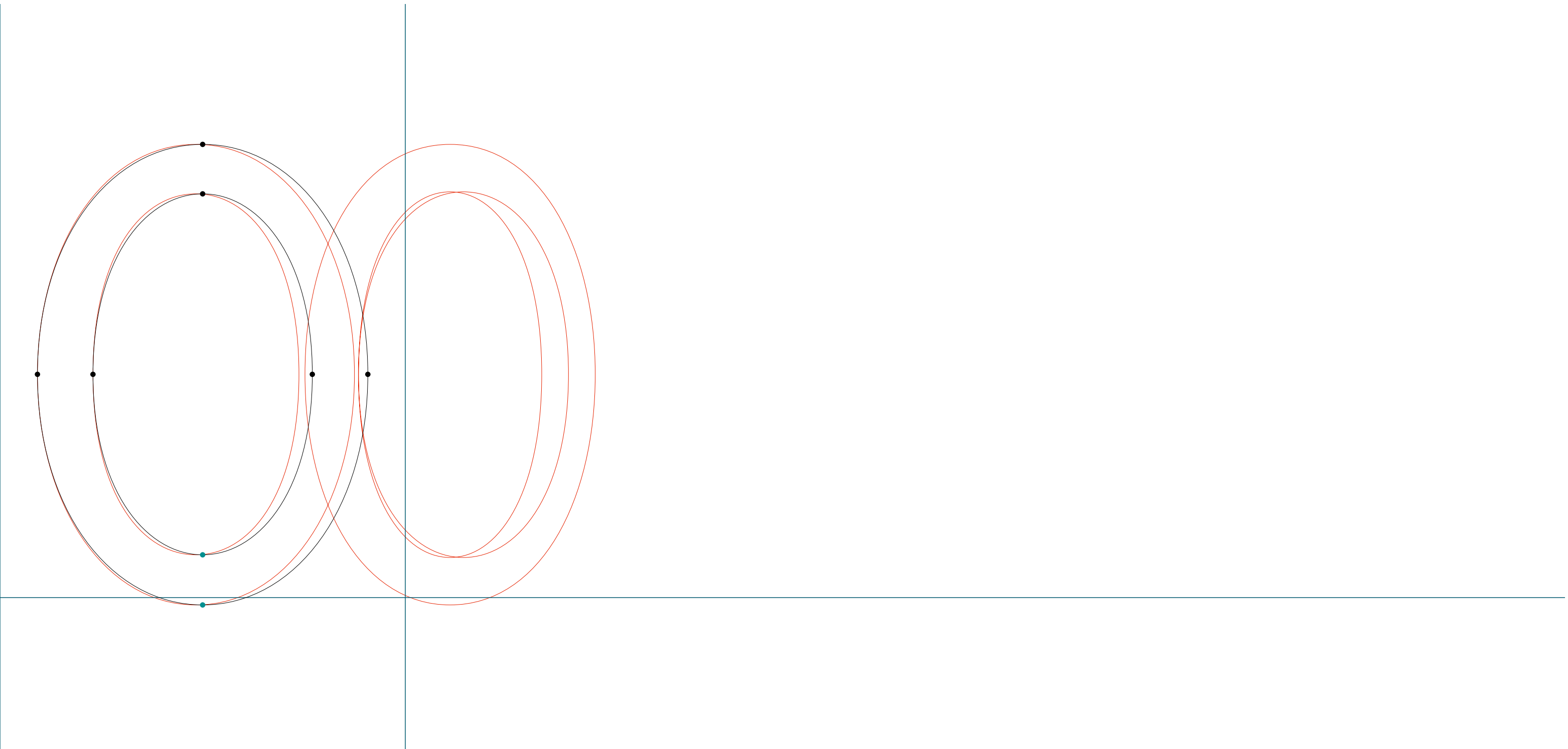

BASE 900

.....
Base900Sans L | Q | RoboFog Sketches | 2010 | Emigre Fonts

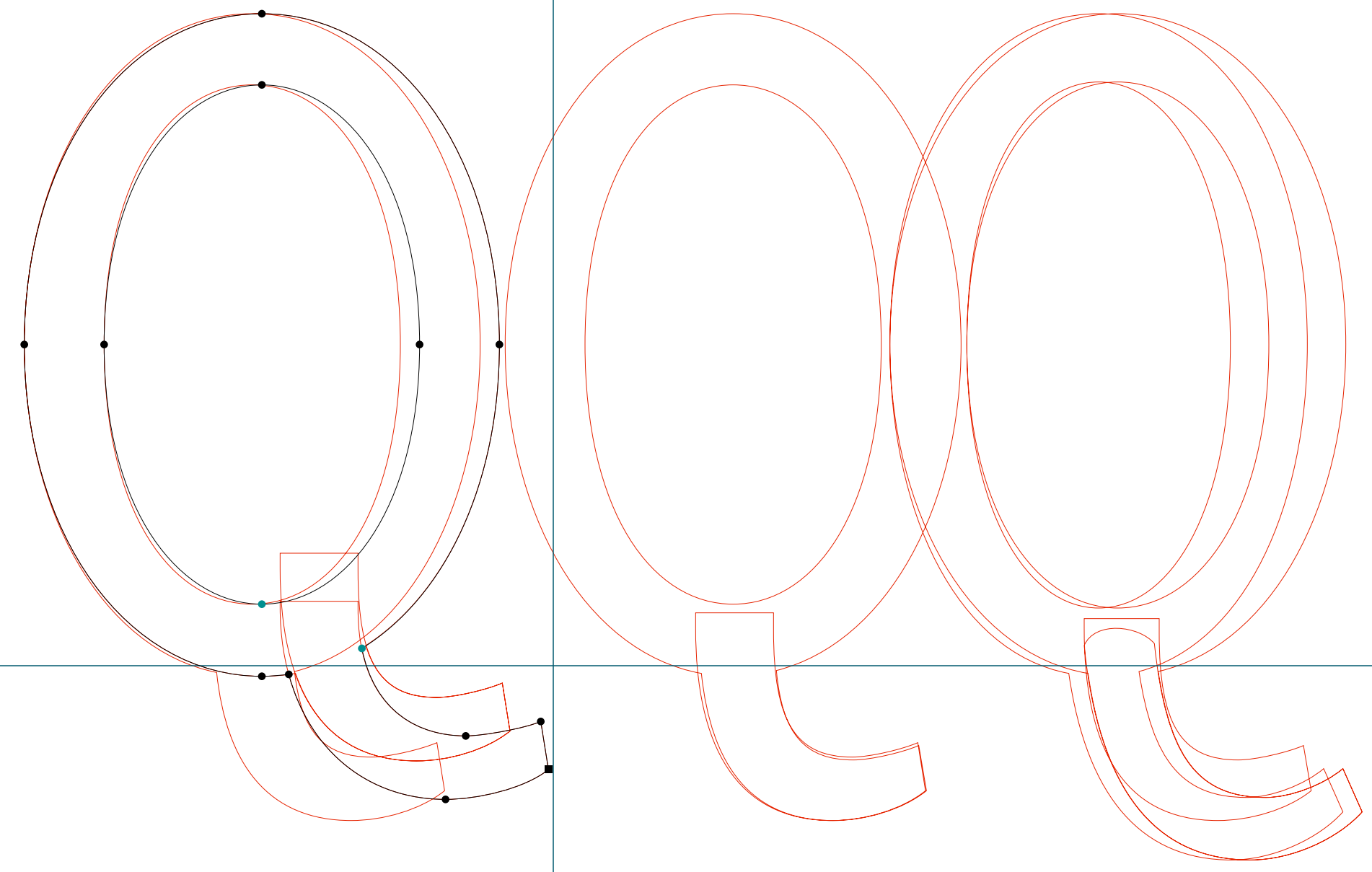

BASE 900

.....
Base900Sans L | W | RoboFog Sketches | 2010 | Emigre Fonts

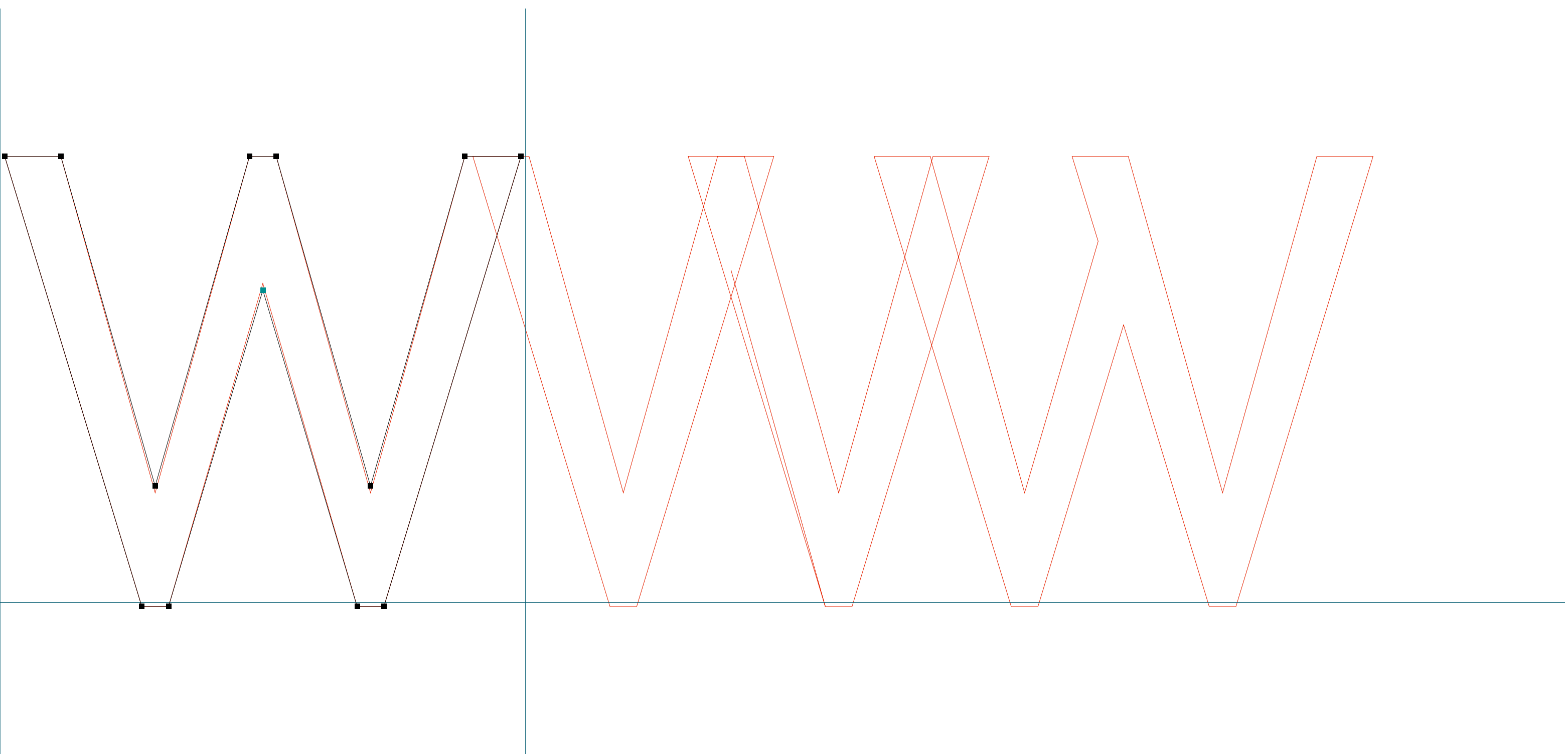

BASE 900

.....
Base900Sans L | X | RoboFog Sketches | 2010 | Emigre Fonts

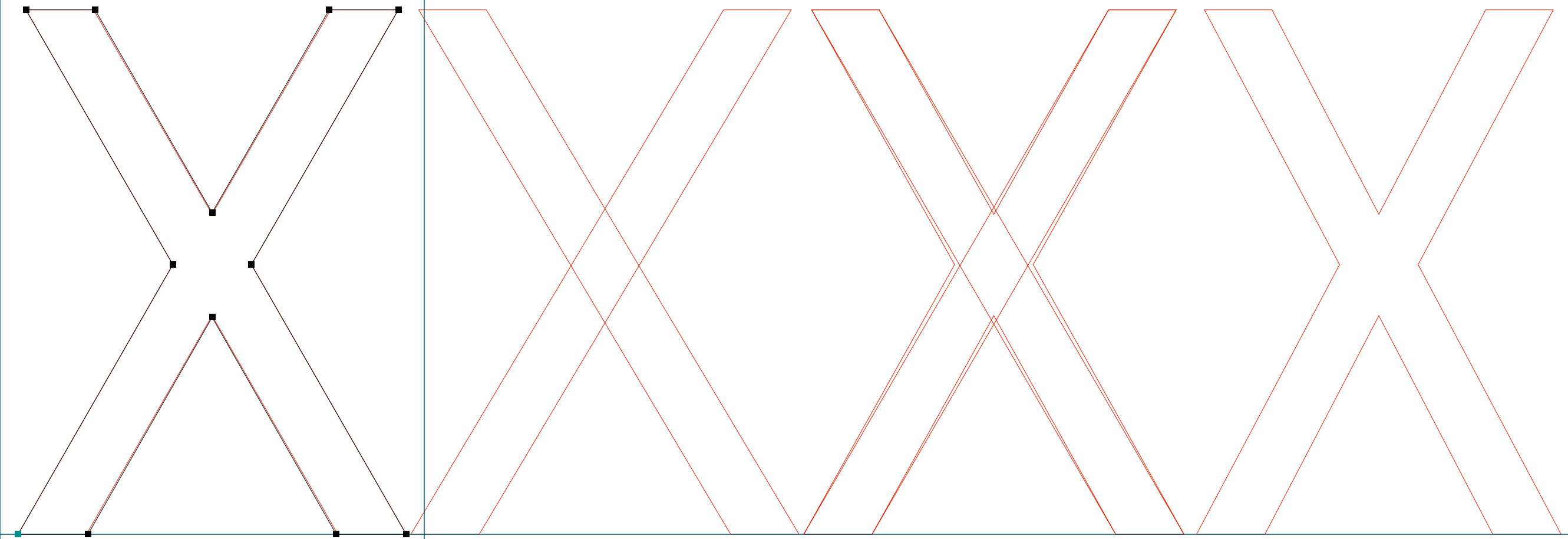

BASE 900

.....
Base900Sans L | Y | RoboFog Sketches | 2010 | Emigre Fonts

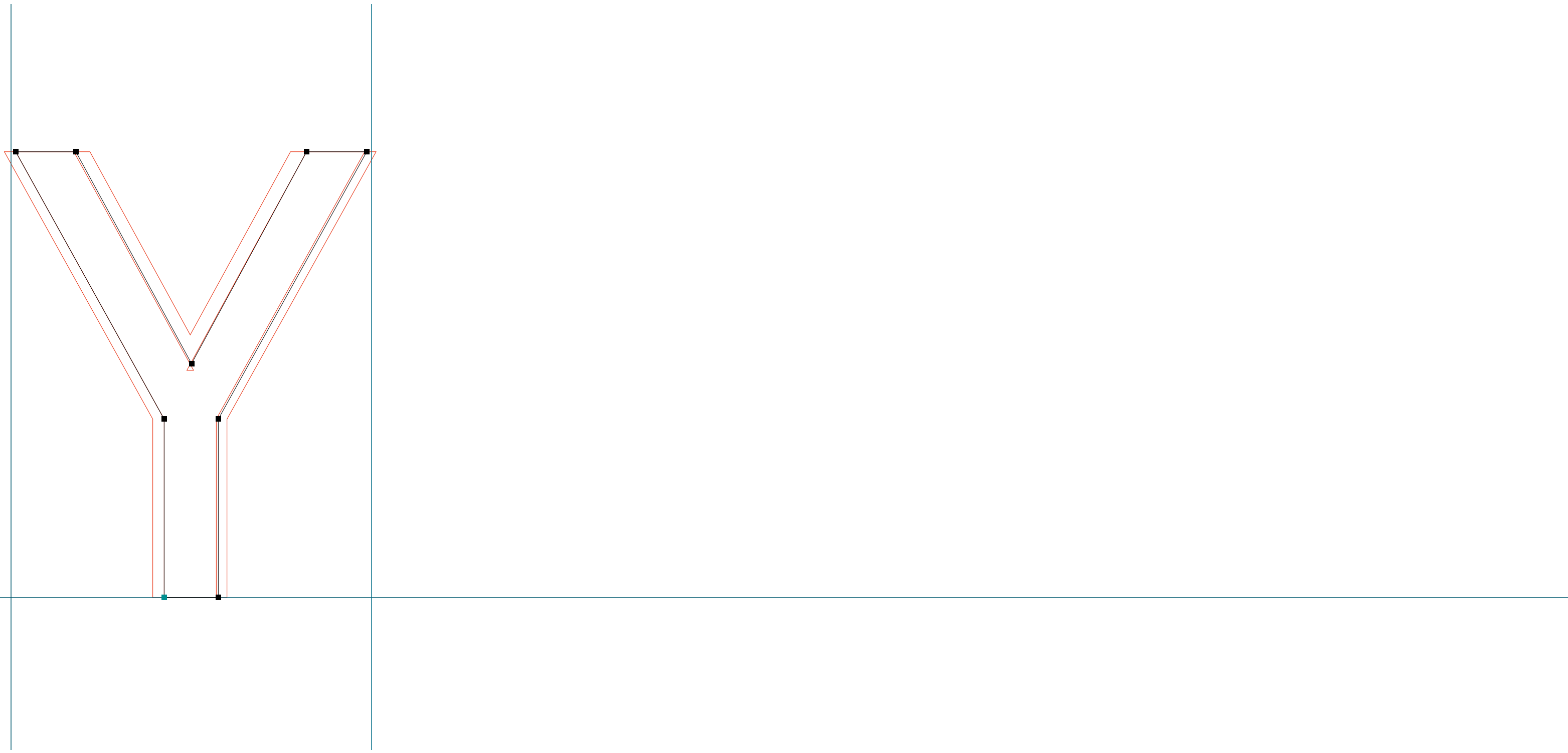

BASE 900

Base900Sans L | c | RoboFog Sketches | 2010 | Emigre Fonts

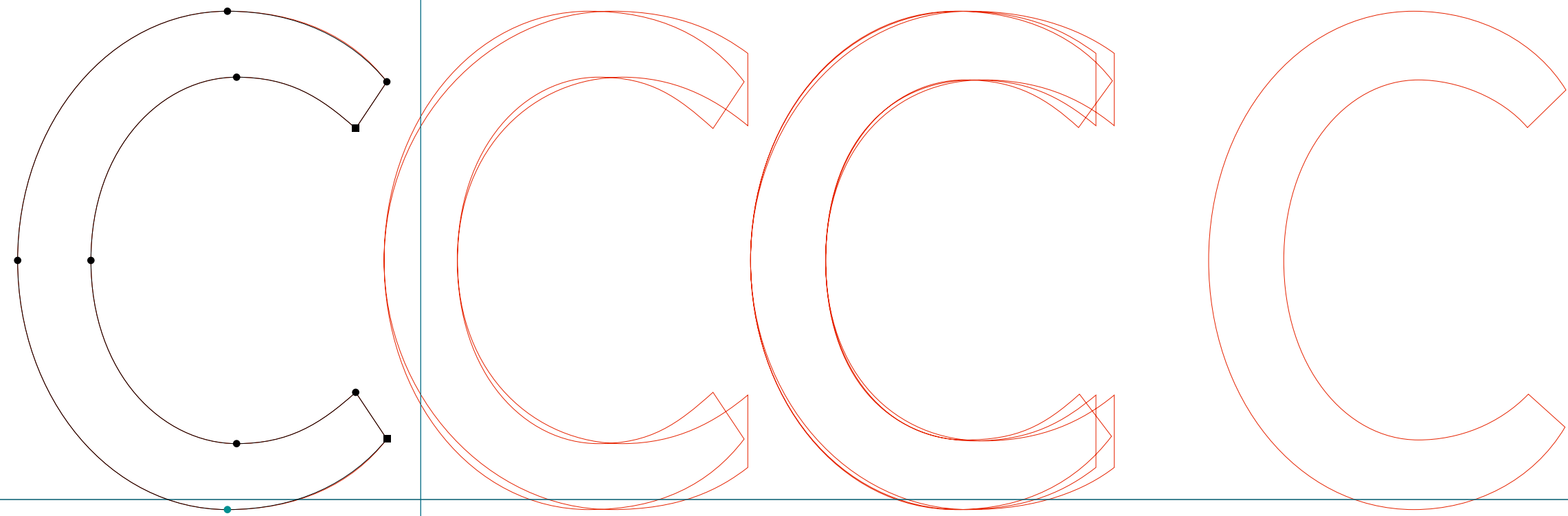

BASE 900

.....
Base900Sans L | d | RoboFog Sketches | 2010 | Emigre Fonts

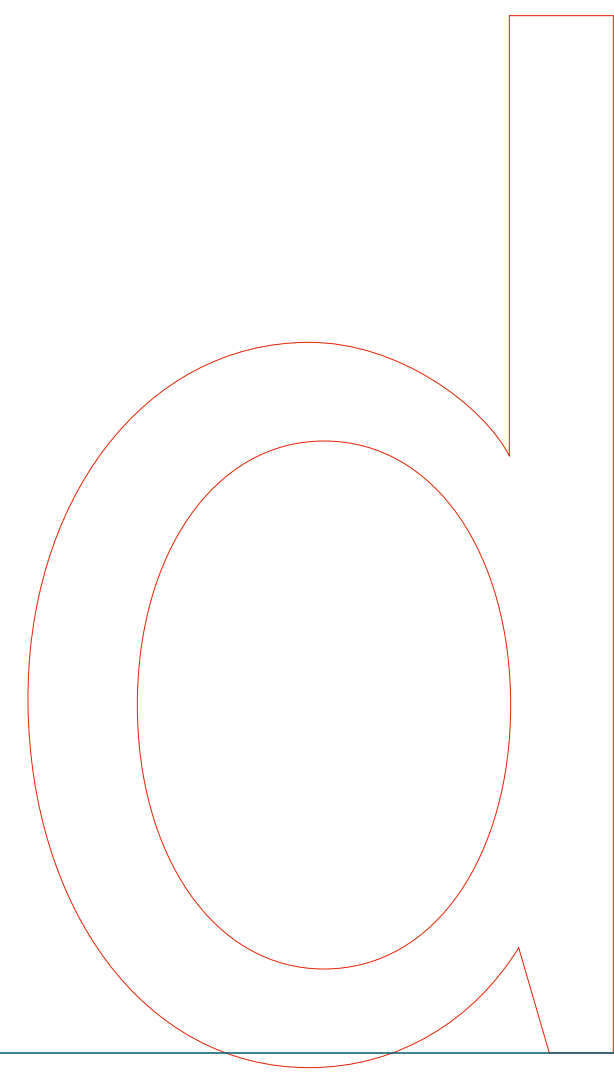
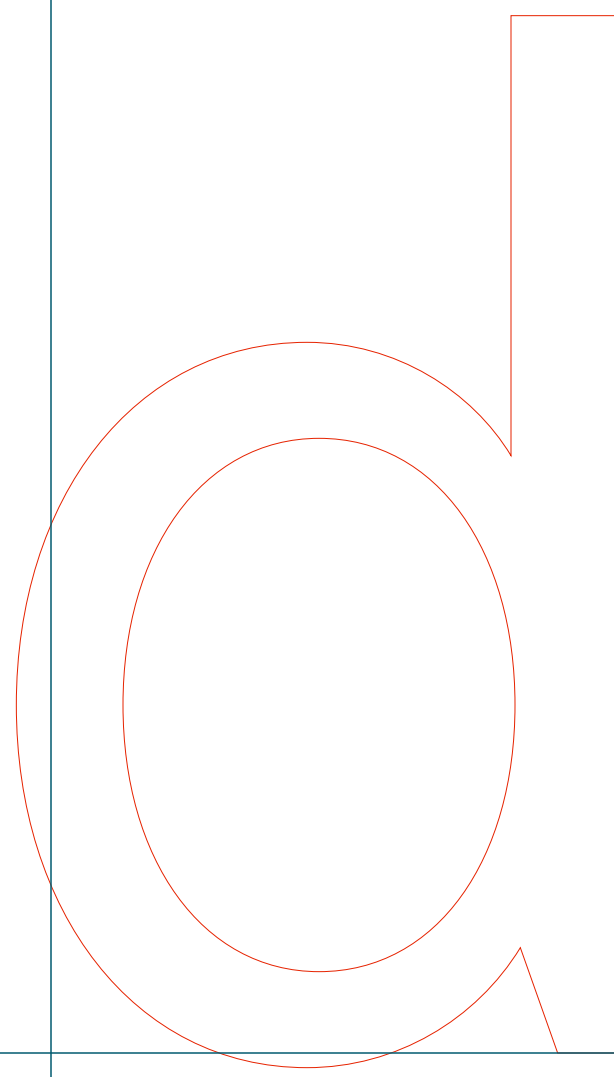
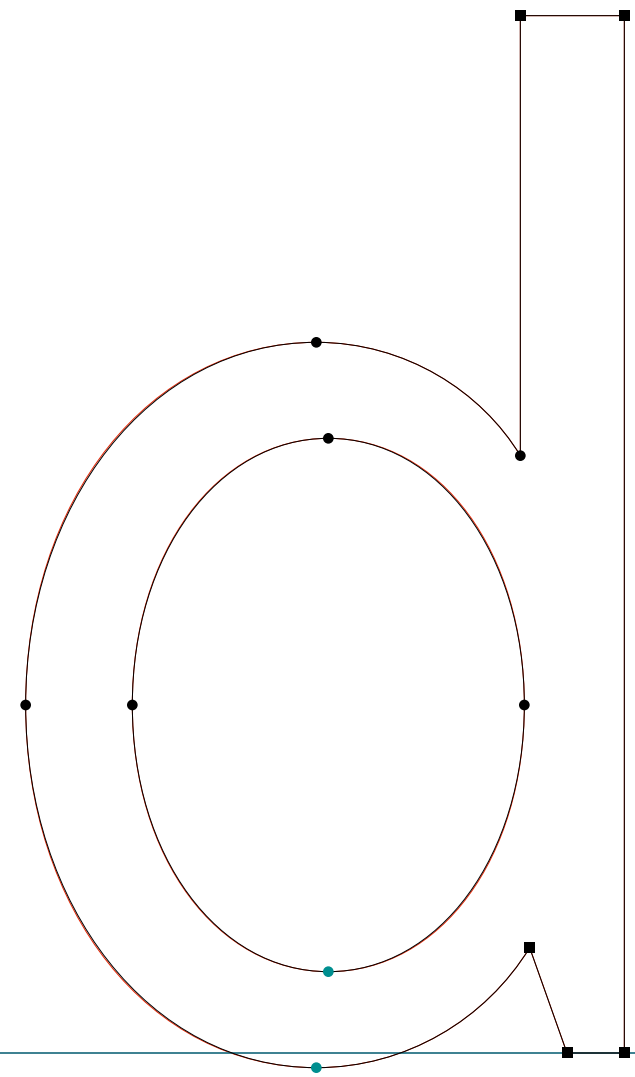

BASE 900

.....
Base900Sans L | e | RoboFog Sketches | 2010 | Emigre Fonts

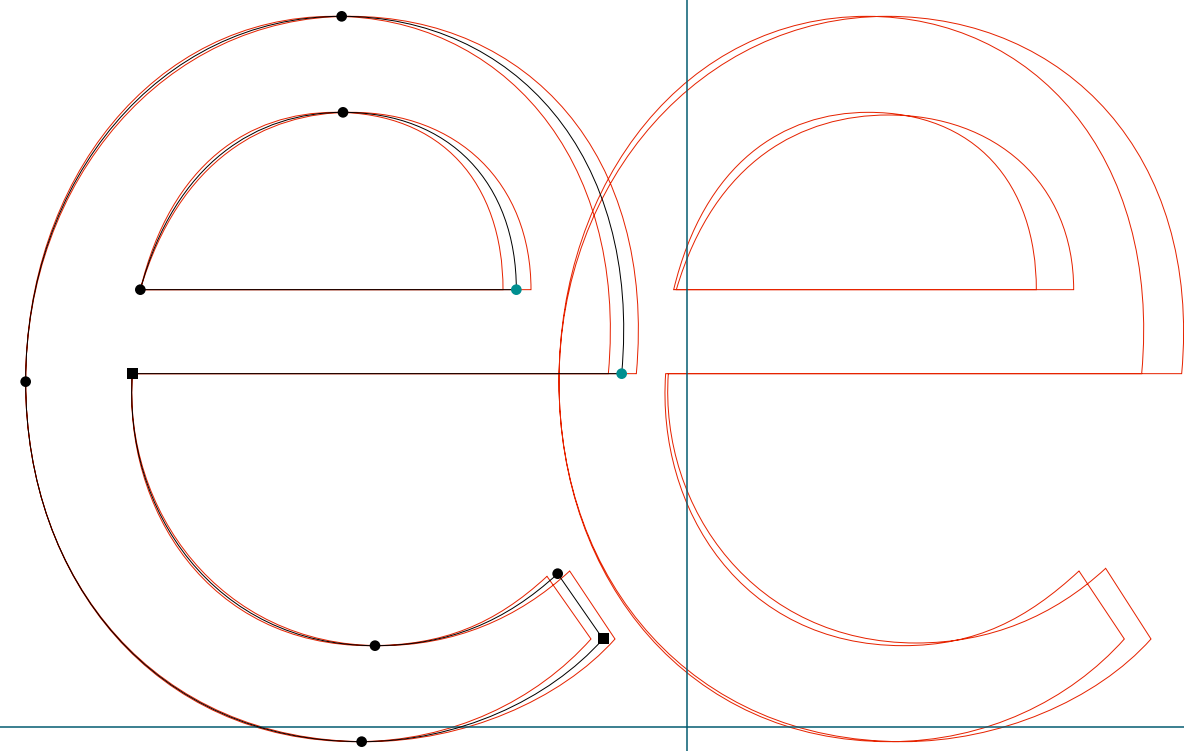

BASE 900

.....
Base900Sans L | f | RoboFog Sketches | 2010 | Emigre Fonts

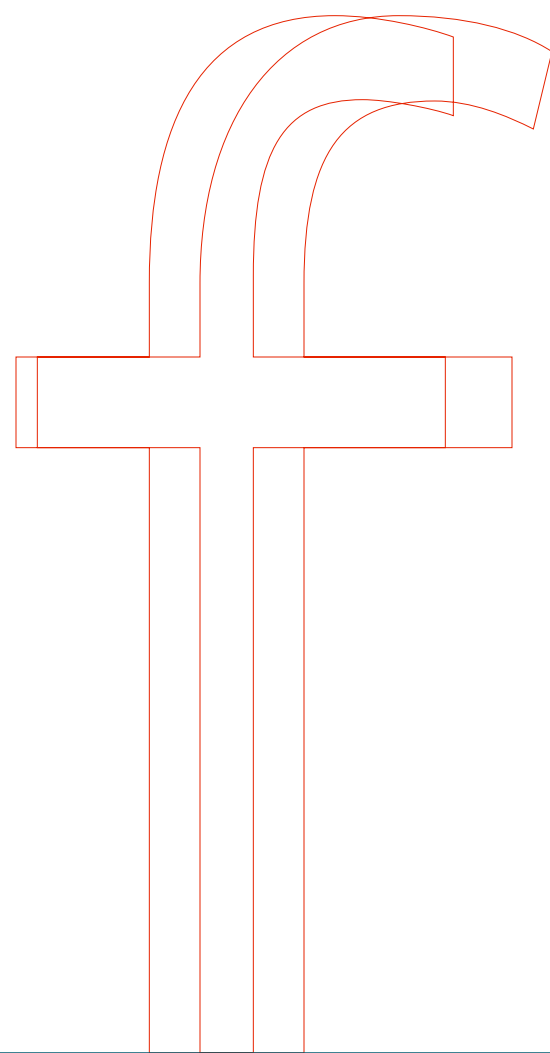
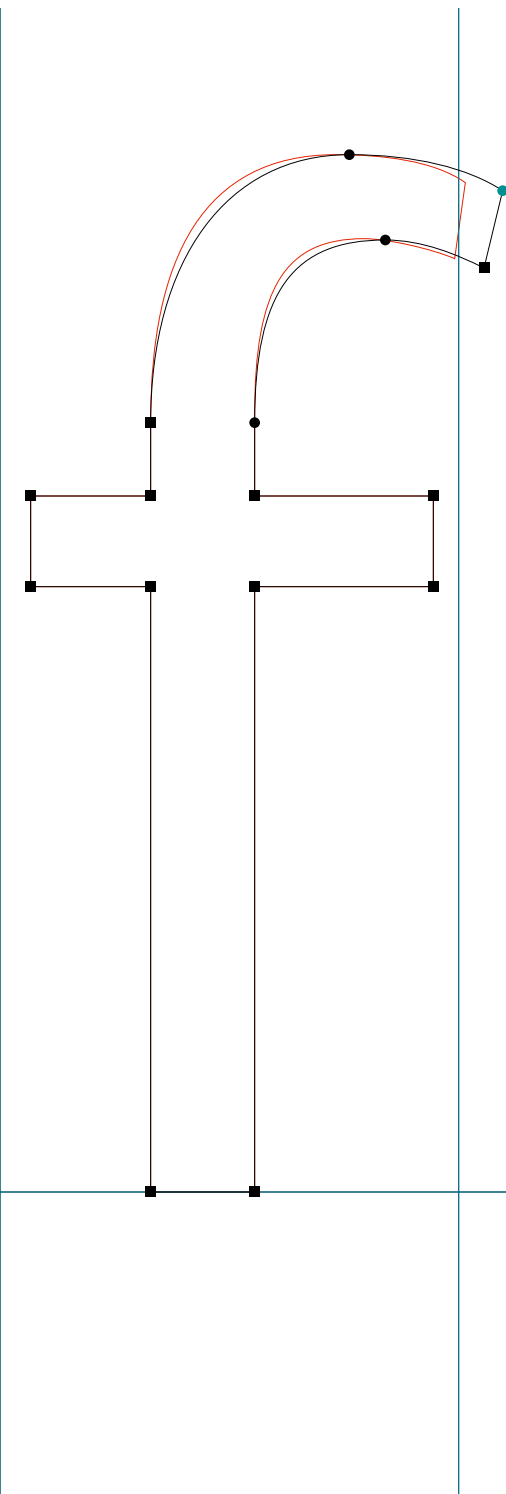

BASE 900

.....
Base900Sans L | h | RoboFog Sketches | 2010 | Emigre Fonts

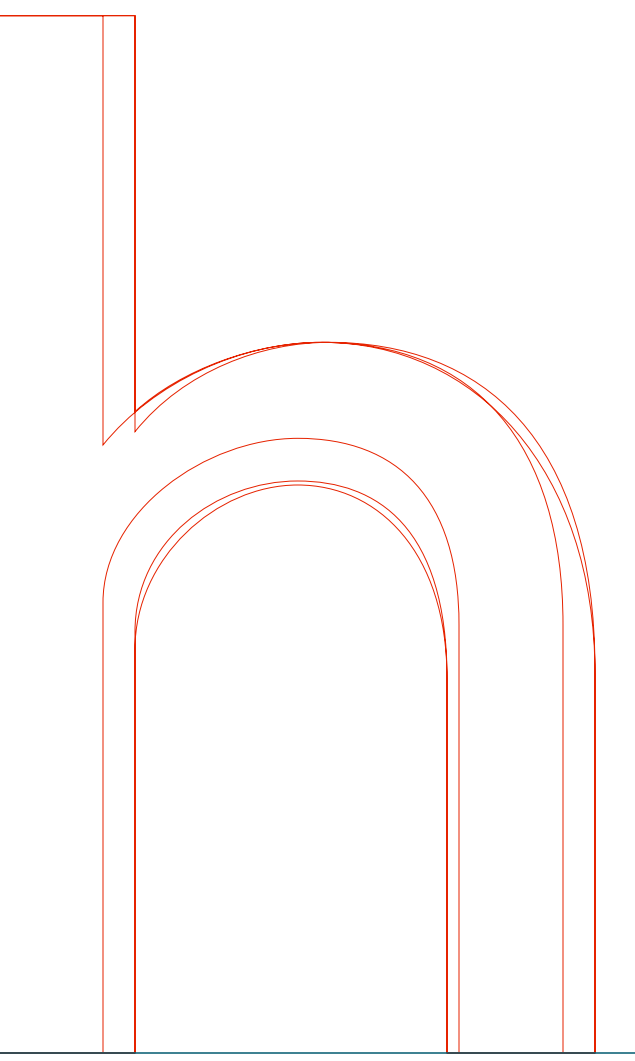
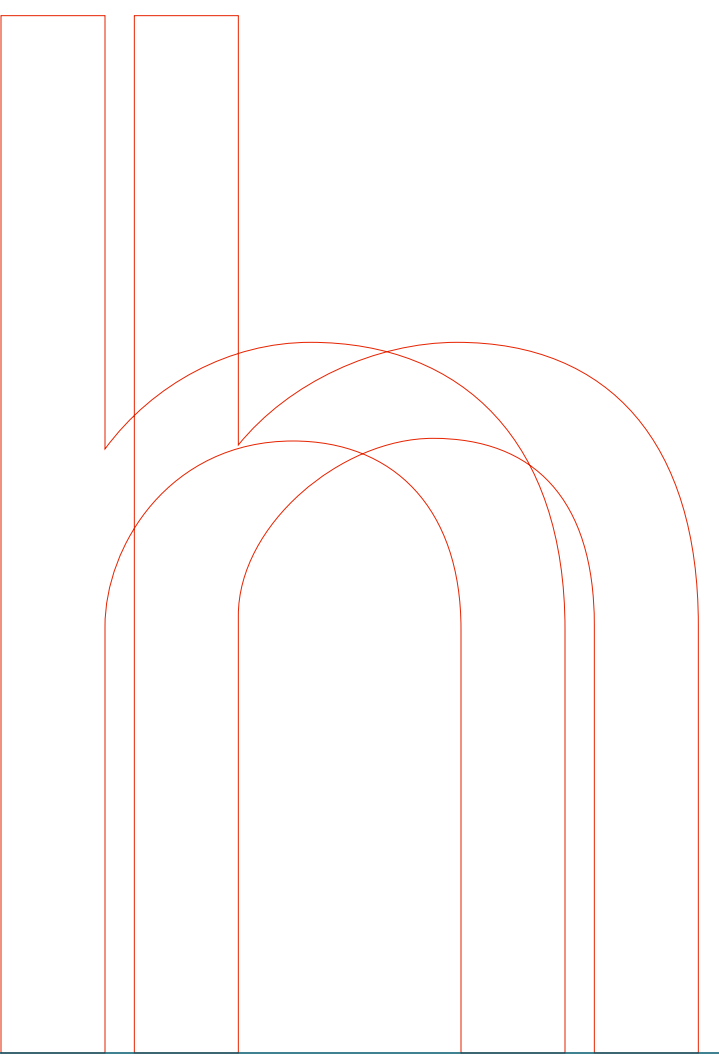
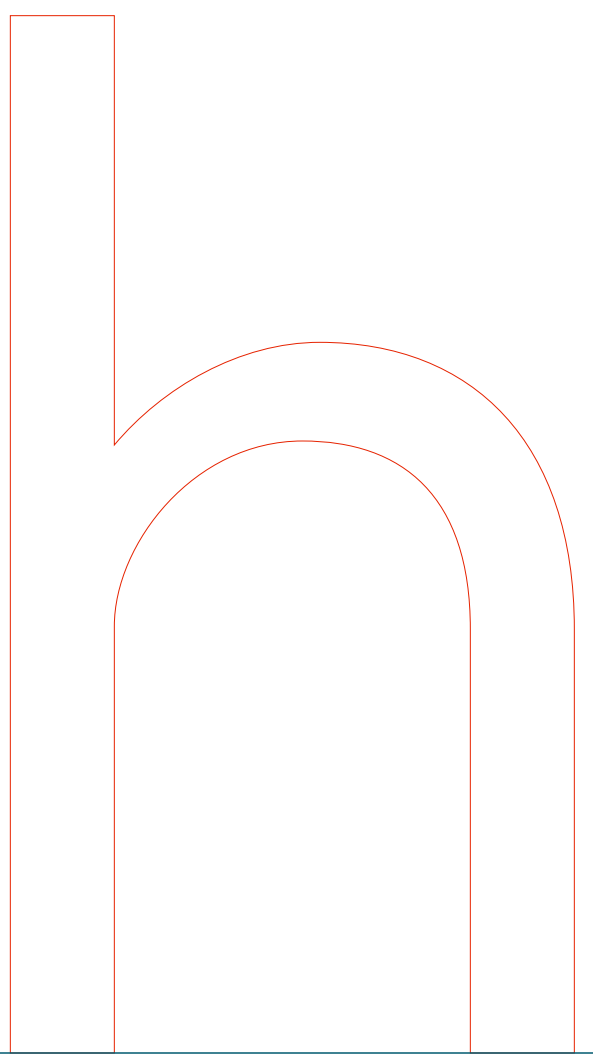
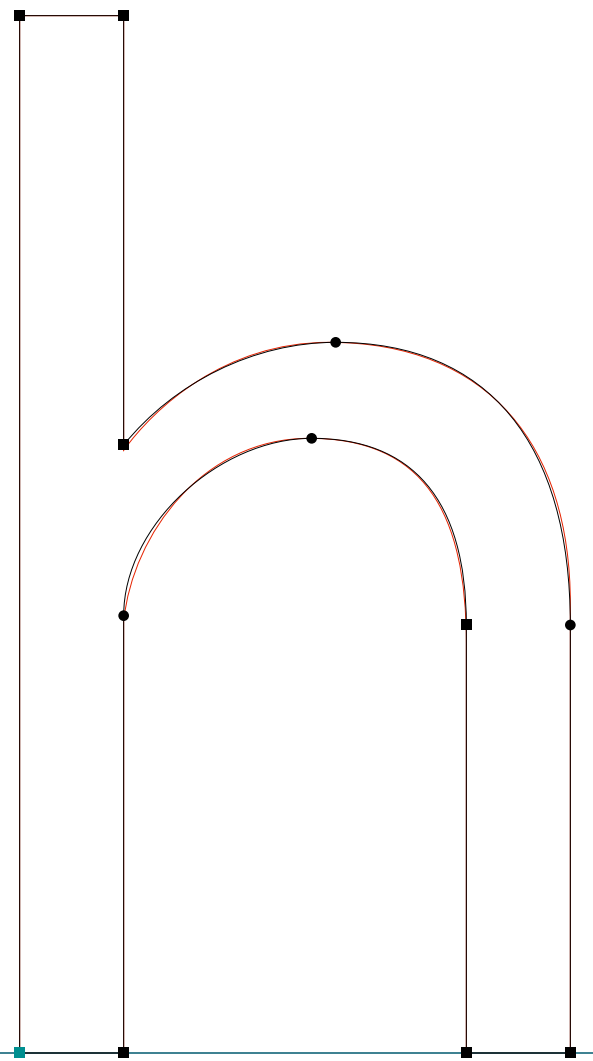

BASE 900

Base900Sans L | j | RoboFog Sketches | 2010 | Emigre Fonts

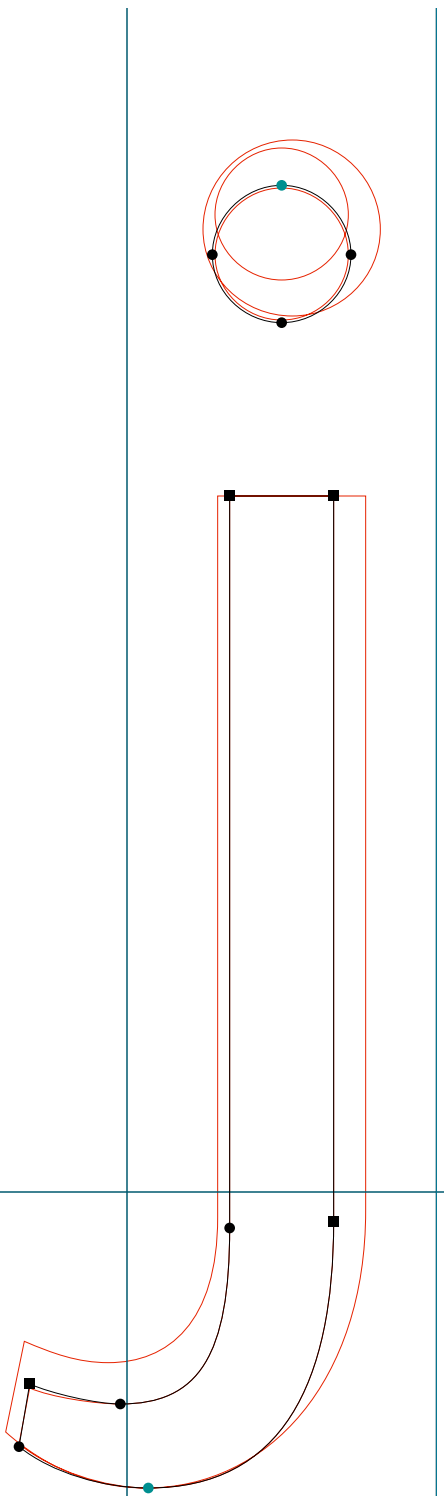

BASE 900

.....
Base900Sans L | k | RoboFog Sketches | 2010 | Emigre Fonts

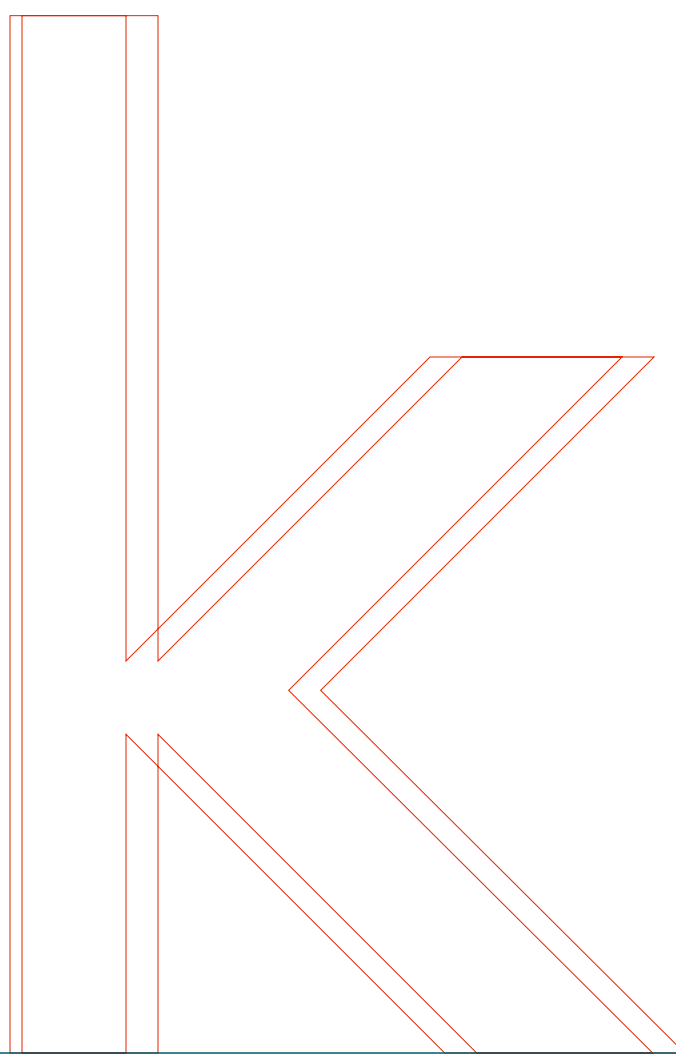
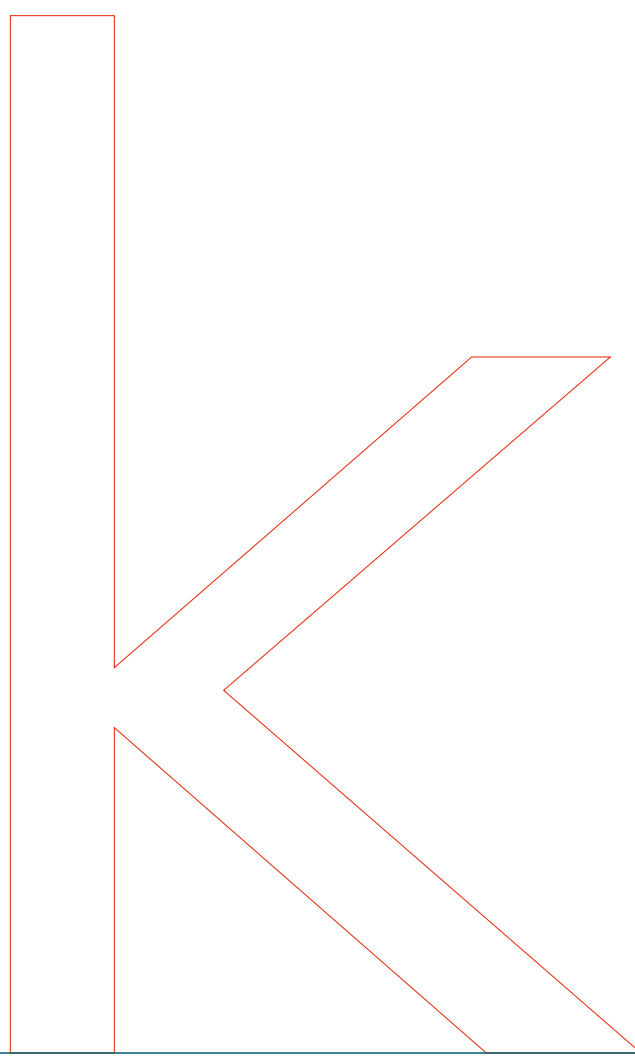
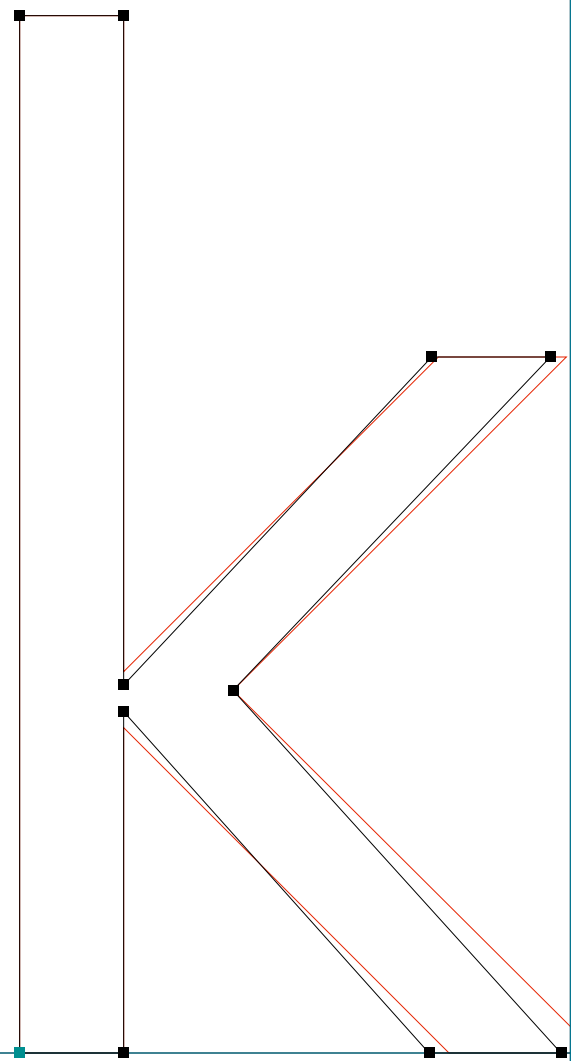

BASE 900

Base900Sans L | m | RoboFog Sketches | 2010 | Emigre Fonts

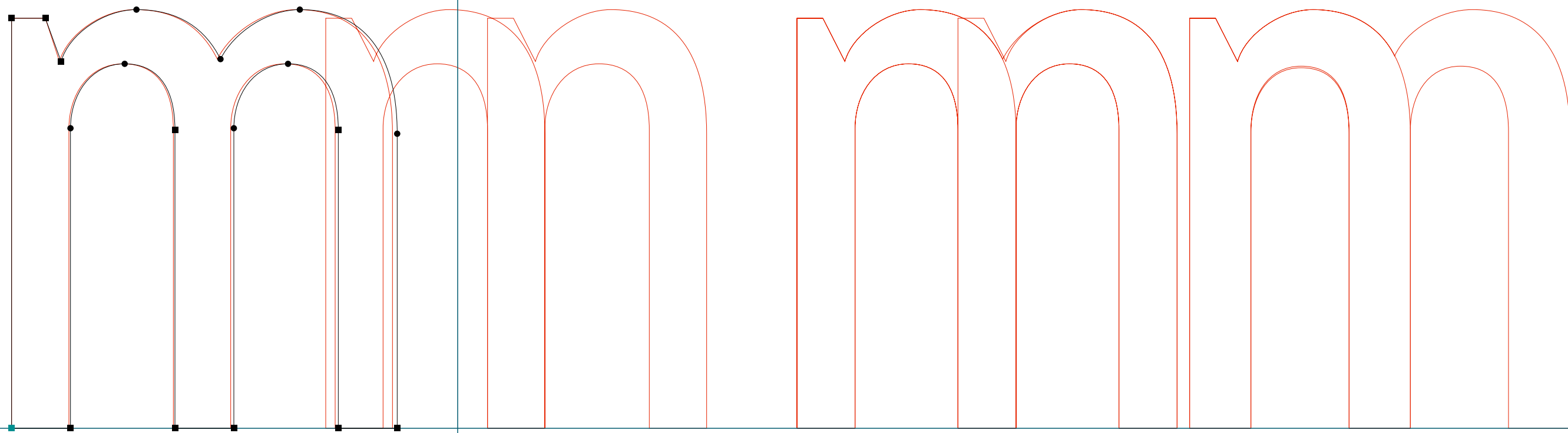

BASE 900

Base900Sans L | n | RoboFog Sketches | 2010 | Emigre Fonts

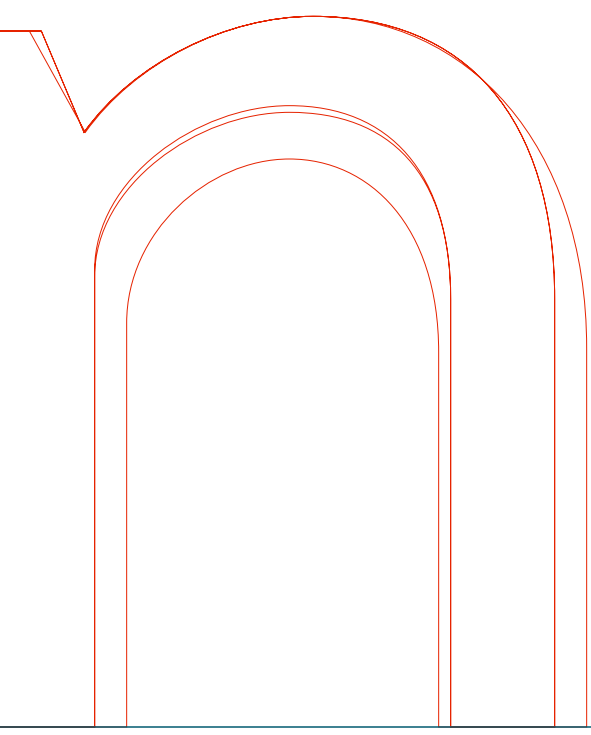
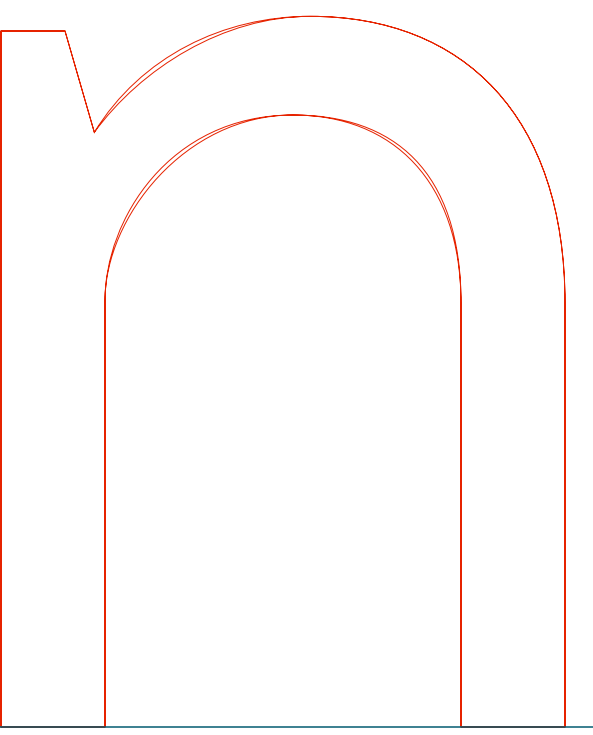
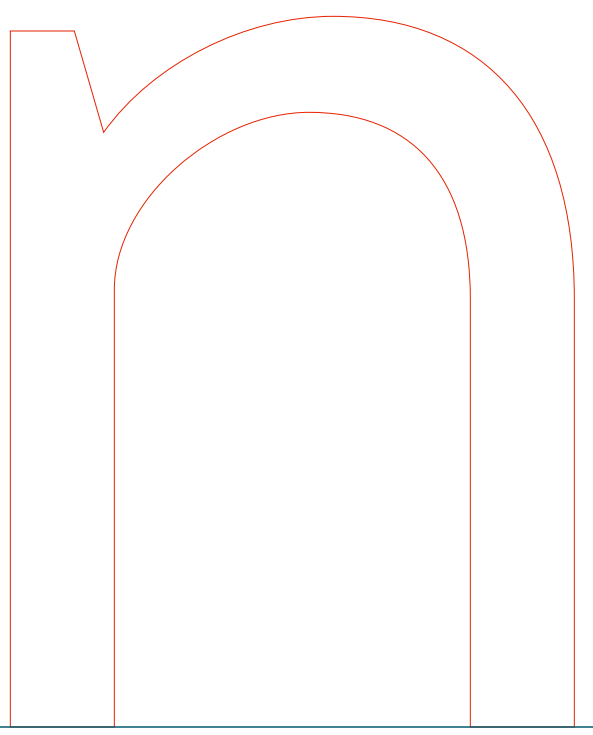
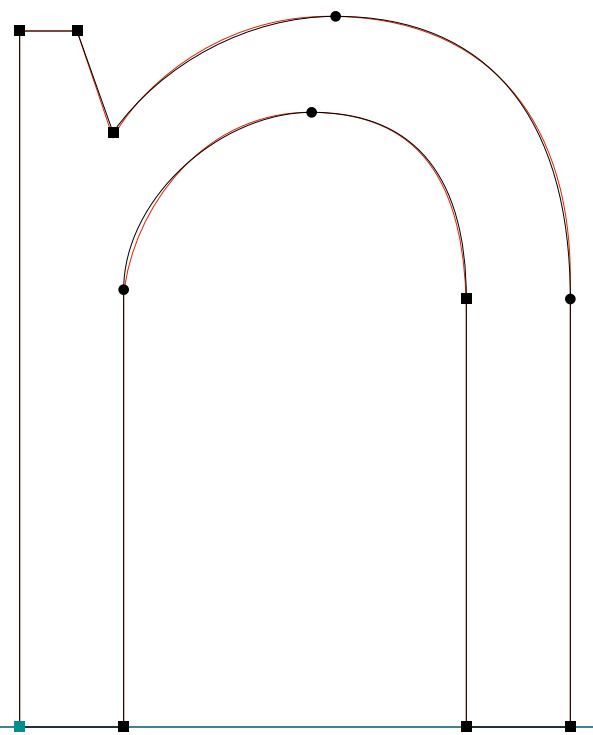

BASE 900

.....
Base900Sans L | o | RoboFog Sketches | 2010 | Emigre Fonts

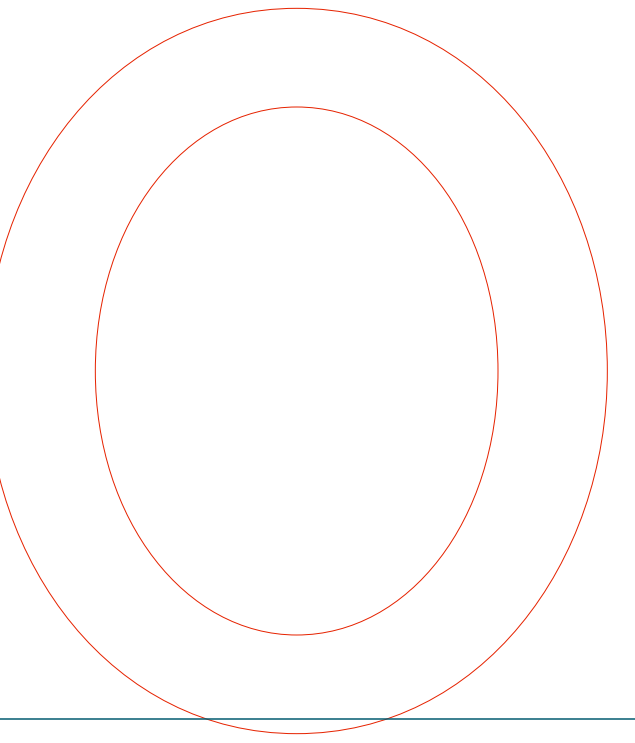
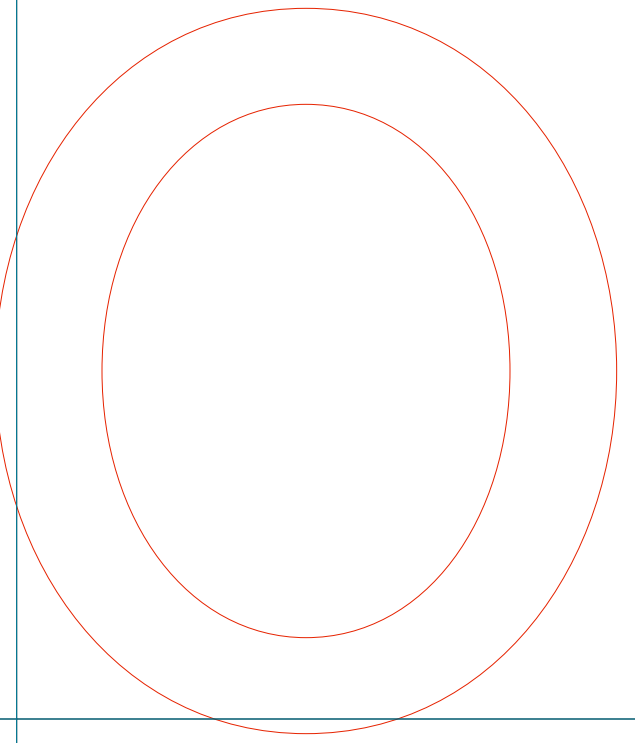
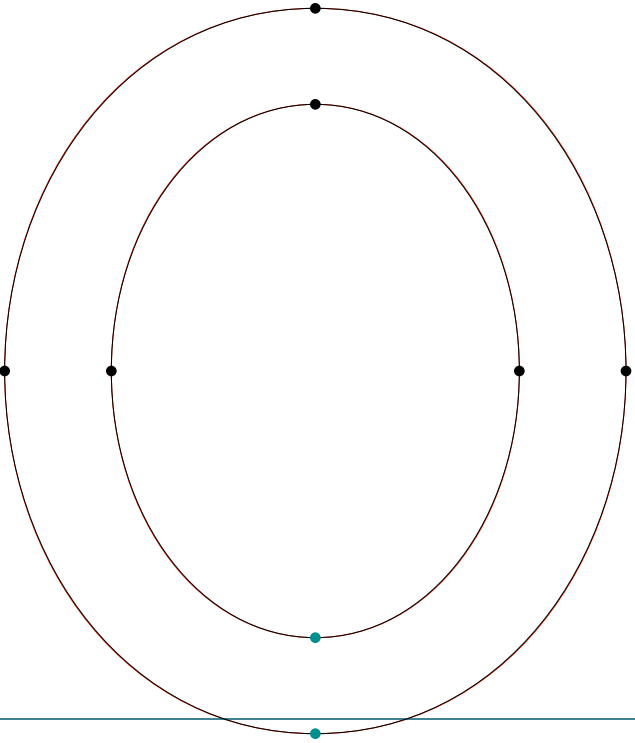

BASE 900

.....
Base900Sans L | r | RoboFog Sketches | 2010 | Emigre Fonts

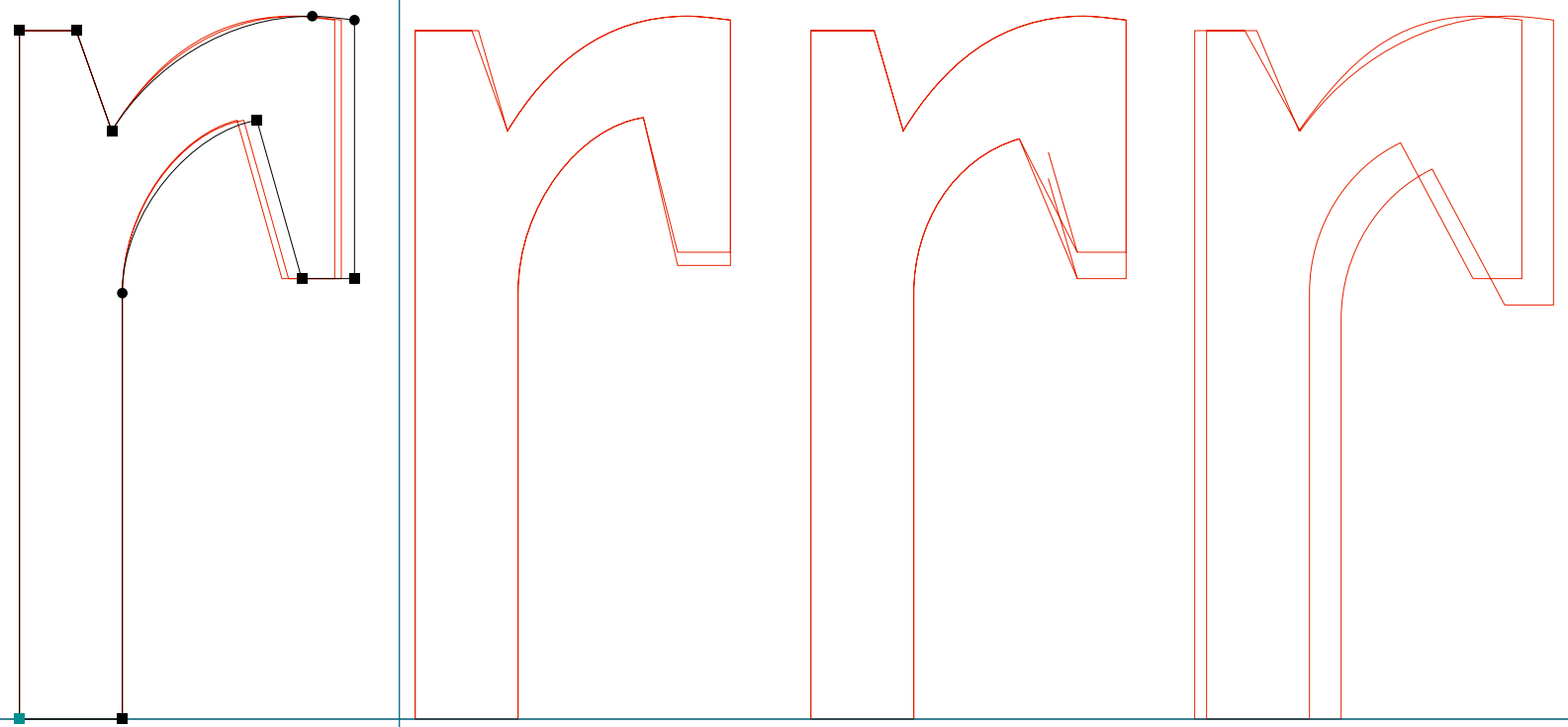

BASE 900

.....
Base900Sans L | s | RoboFog Sketches | 2010 | Emigre Fonts

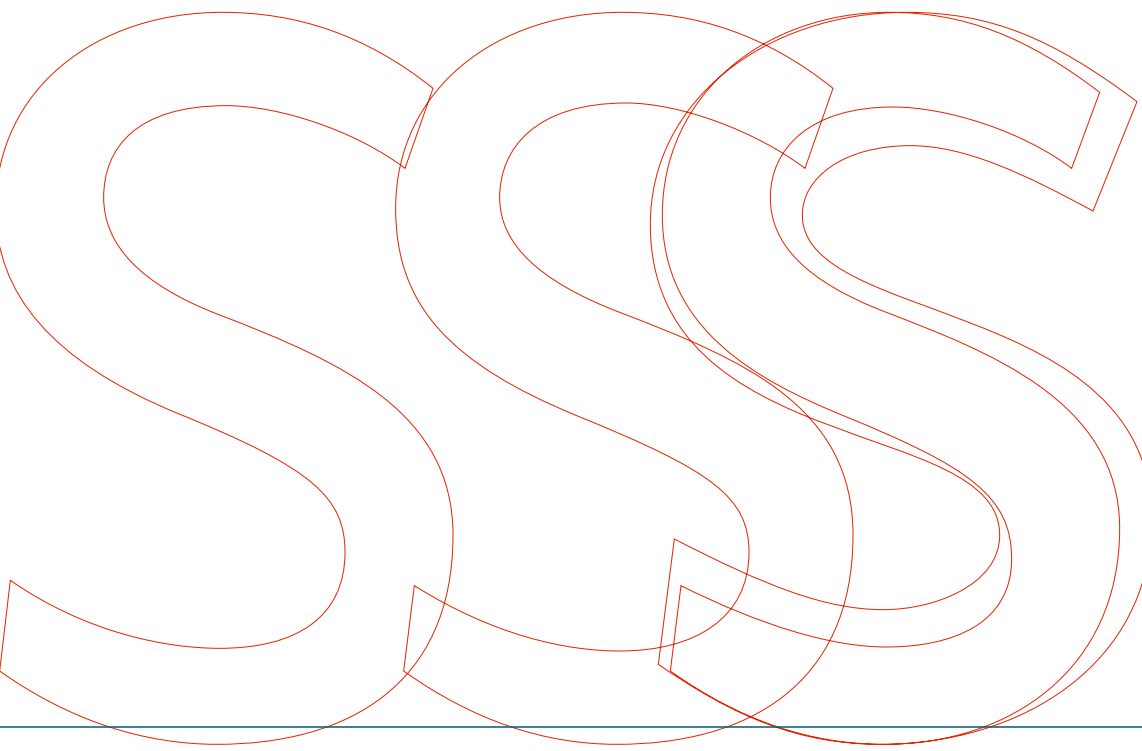
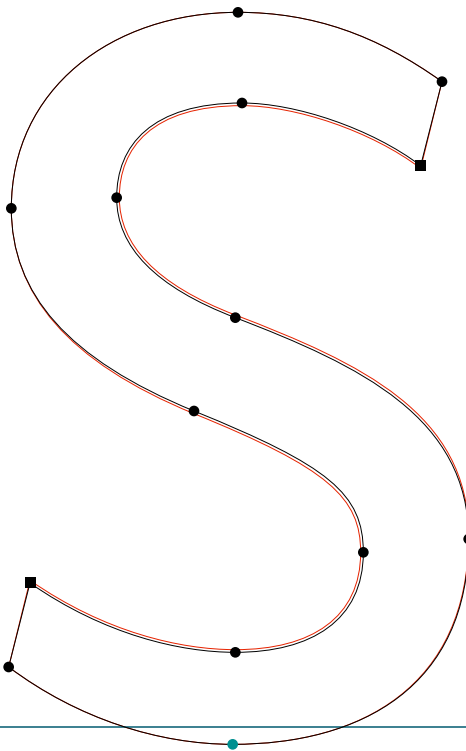

BASE 900

Base900Sans L | t | RoboFog Sketches | 2010 | Emigre Fonts

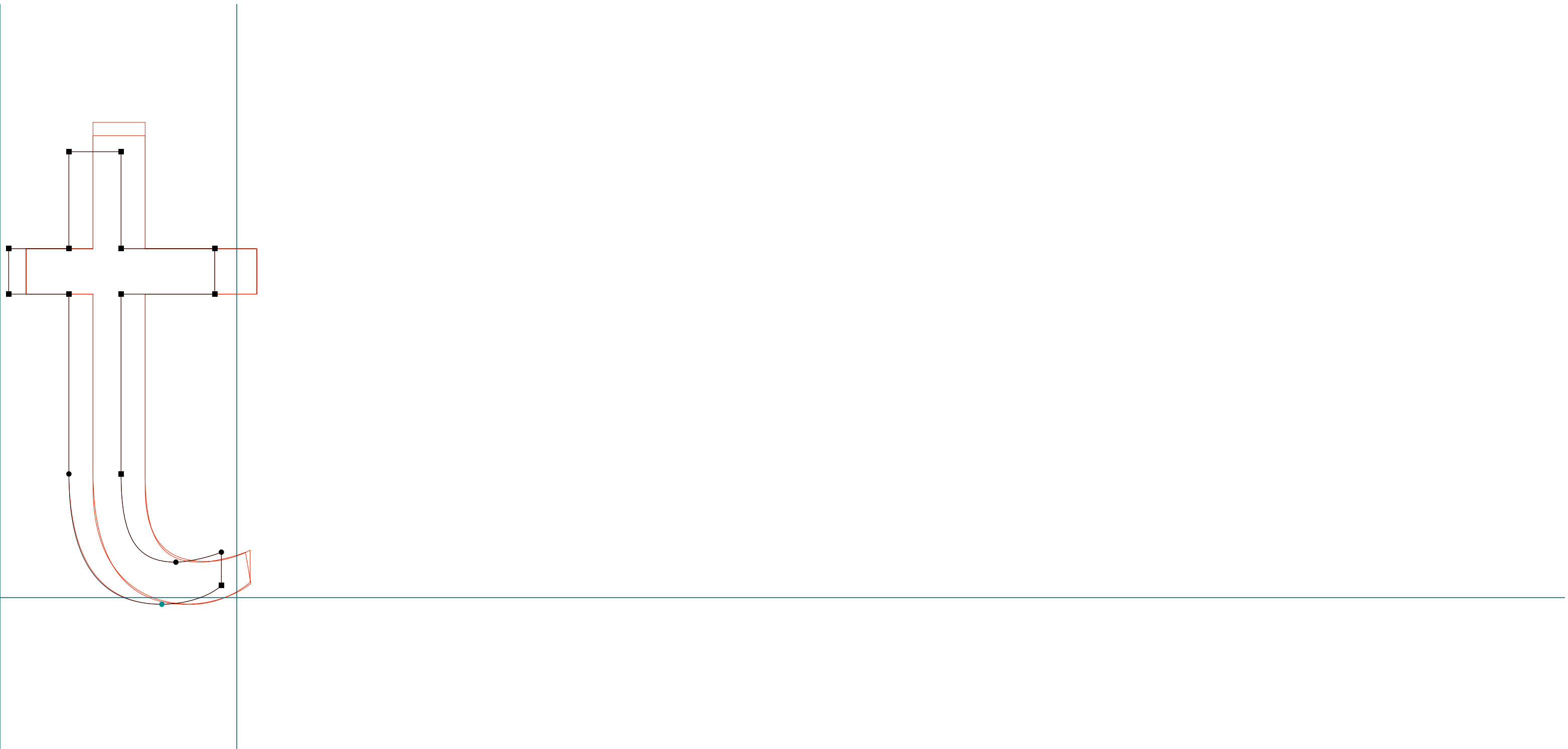

BASE 900

.....
Base900Sans L | u | RoboFog Sketches | 2010 | Emigre Fonts

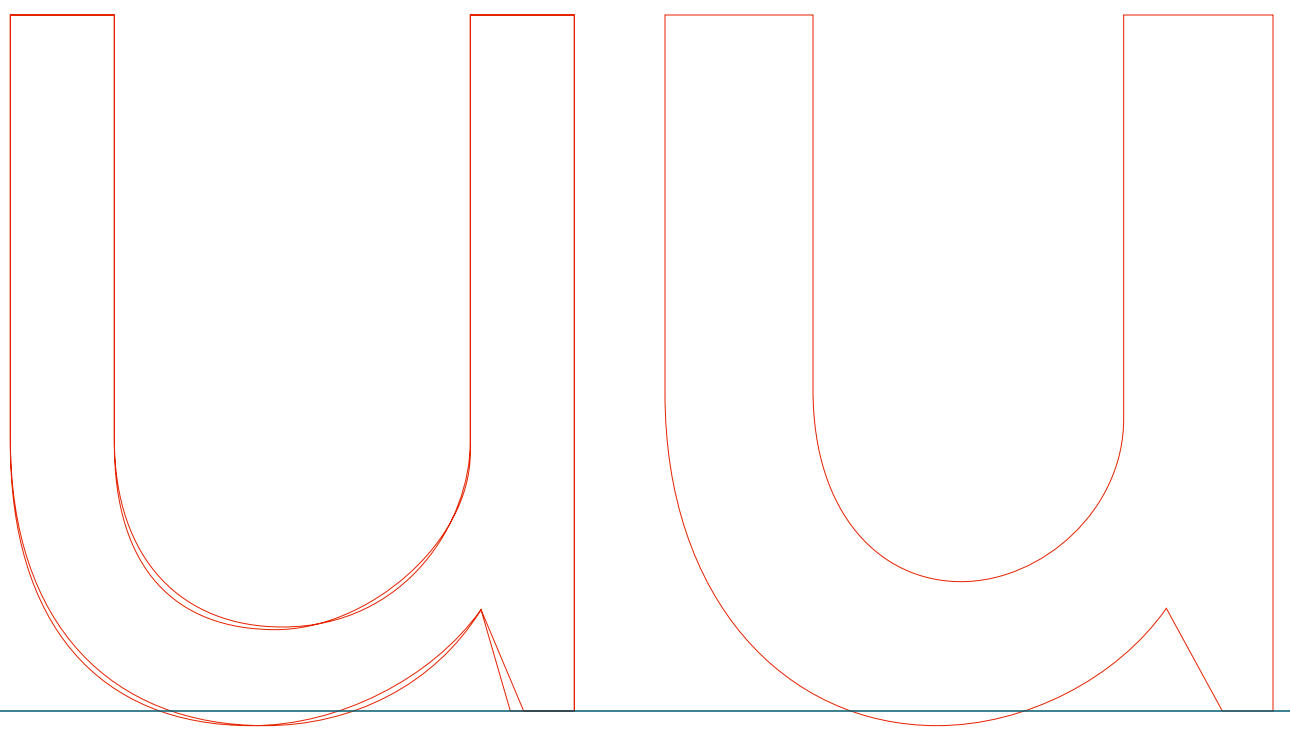
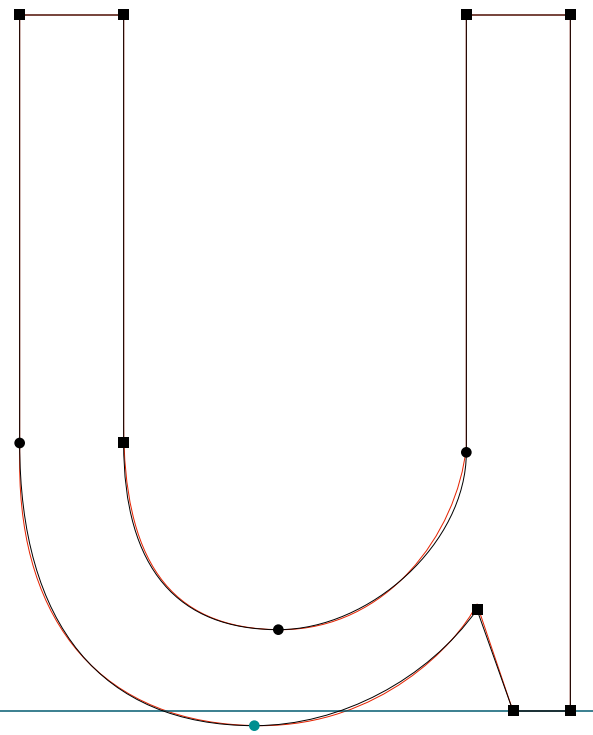

BASE 900

.....
Base900Sans L | w | RoboFog Sketches | 2010 | Emigre Fonts

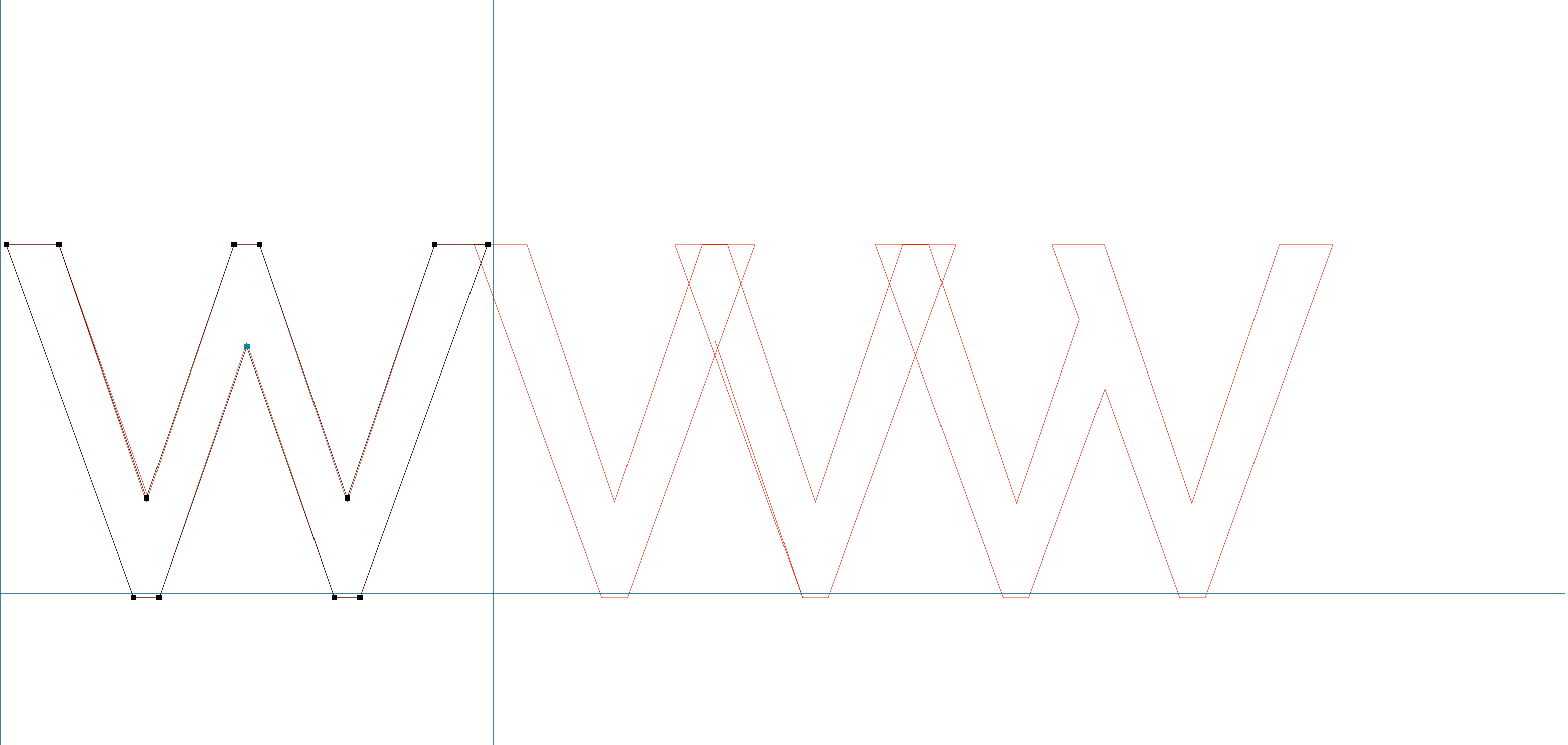

BASE 900

Base900Sans L | y | RoboFog Sketches | 2010 | Emigre Fonts

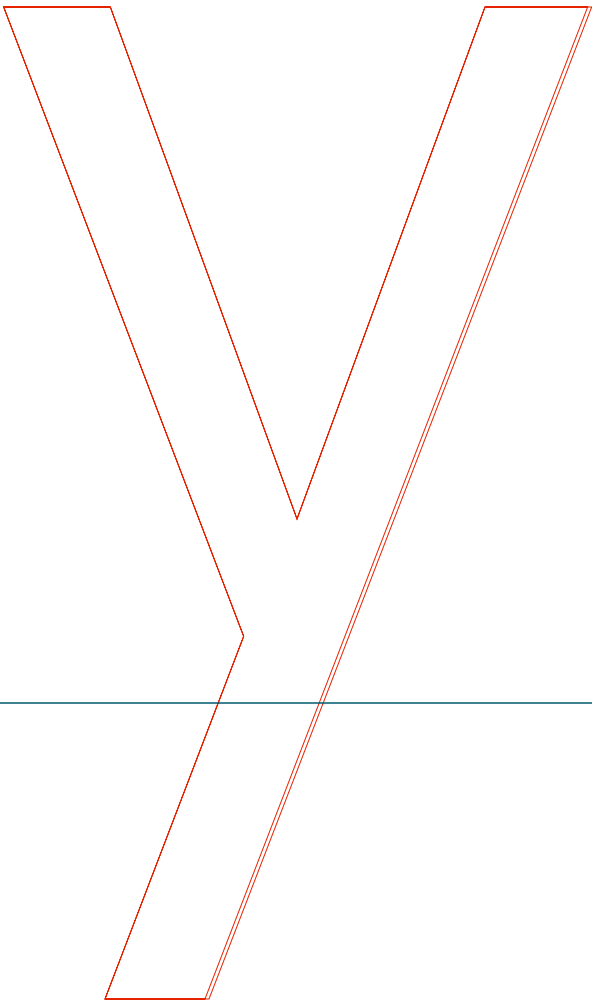
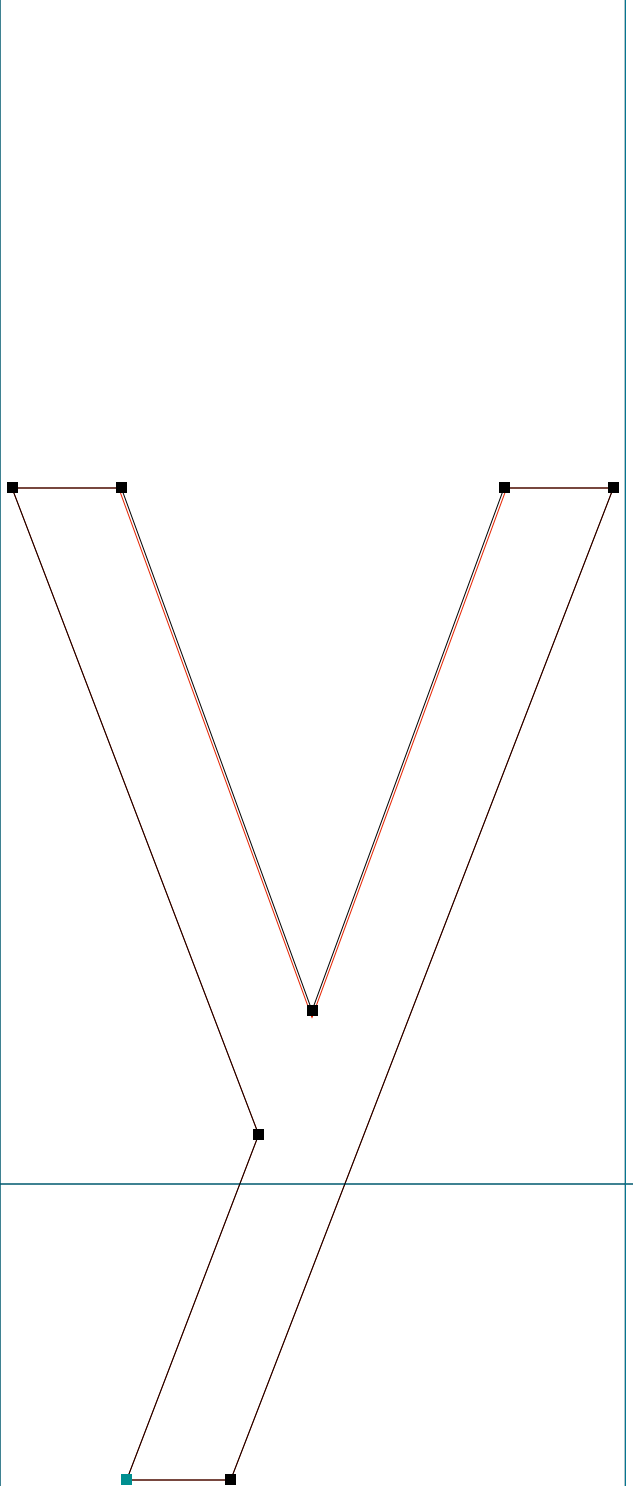

BASE 900

Base900Sans L | cent | RoboFog Sketches | 2010 | Emigre Fonts

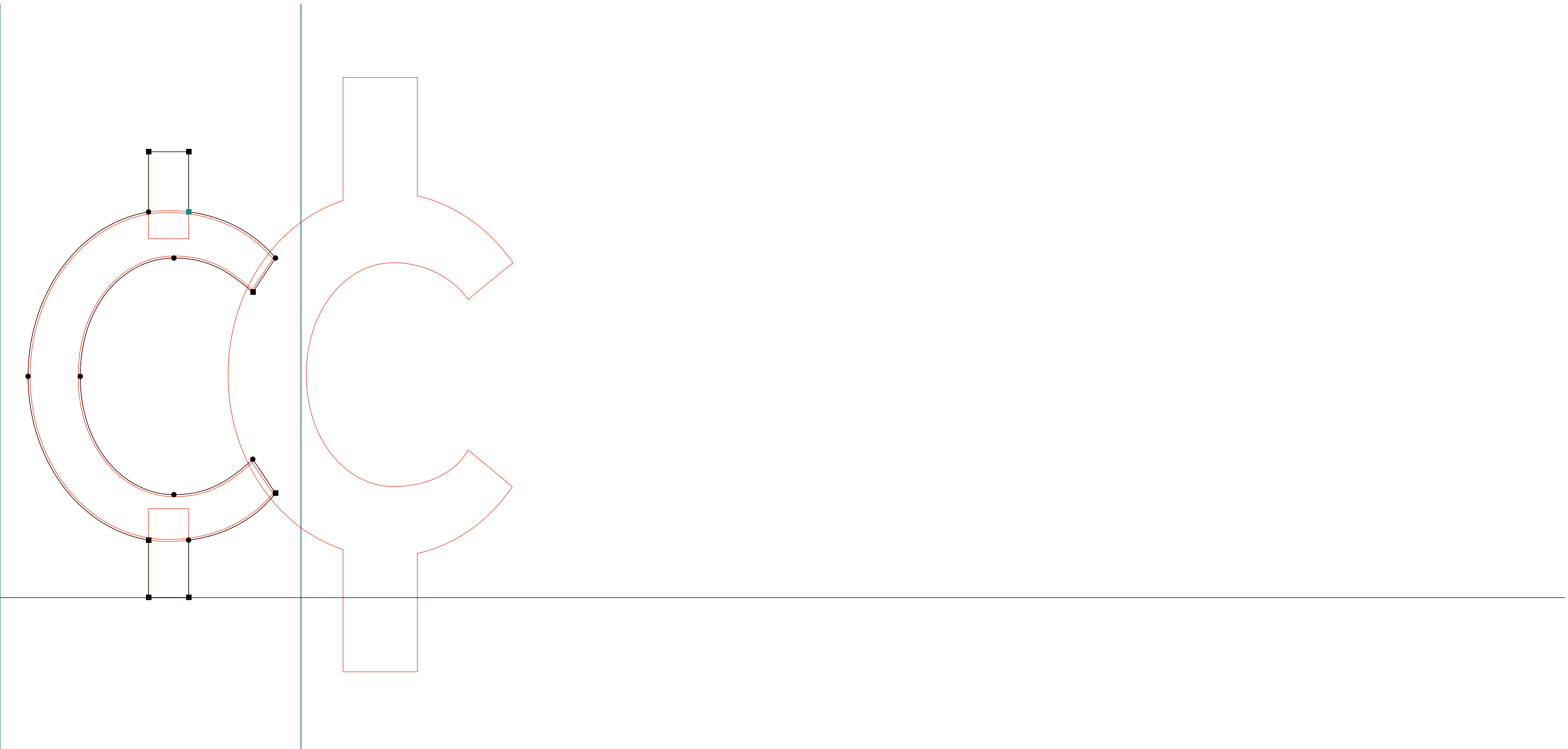

BASE 900

.....
Base900Sans L | lessequal | RoboFog Sketches | 2010 | Emigre Fonts

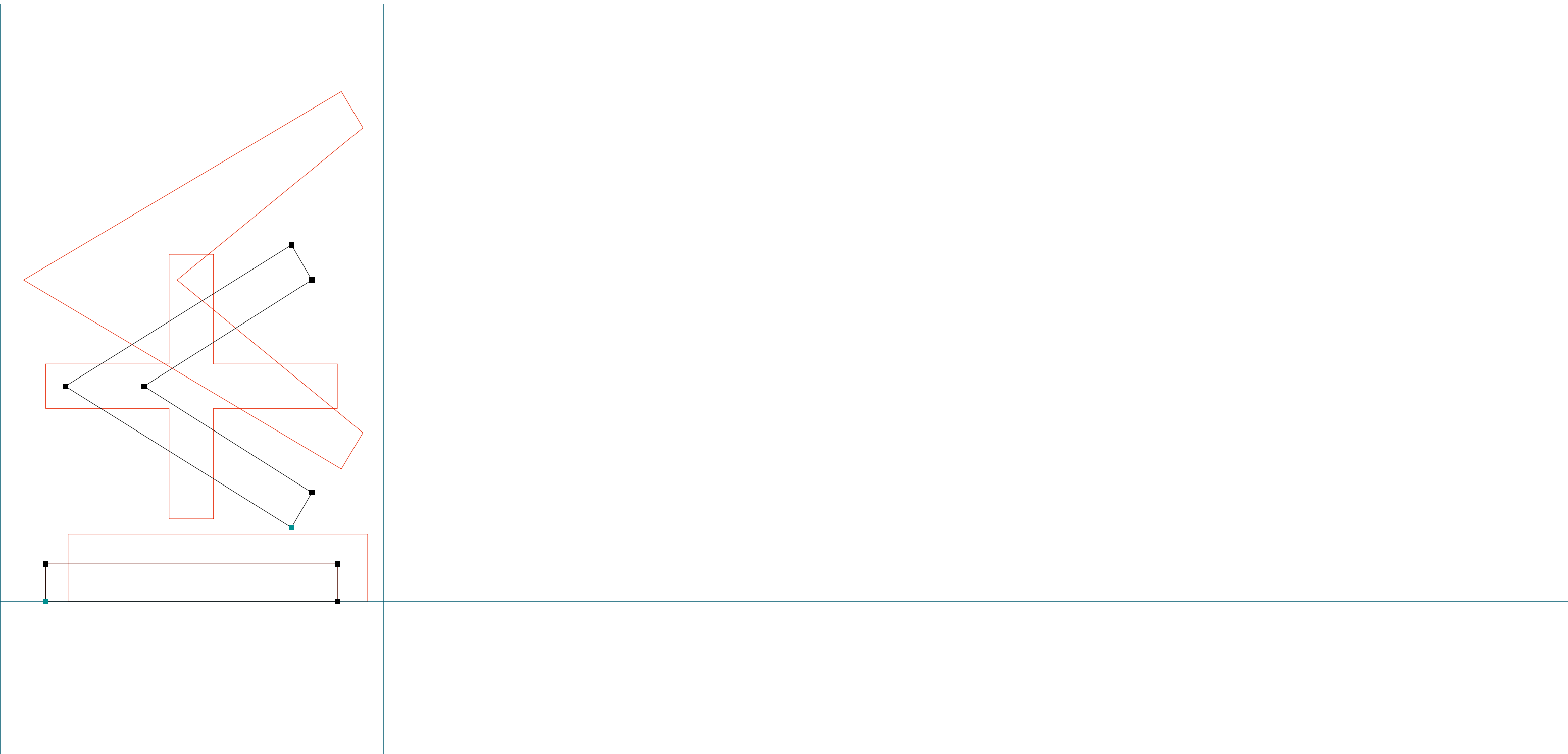

BASE 900

Base900Sans L | currency | RoboFog Sketches | 2010 | Emigre Fonts

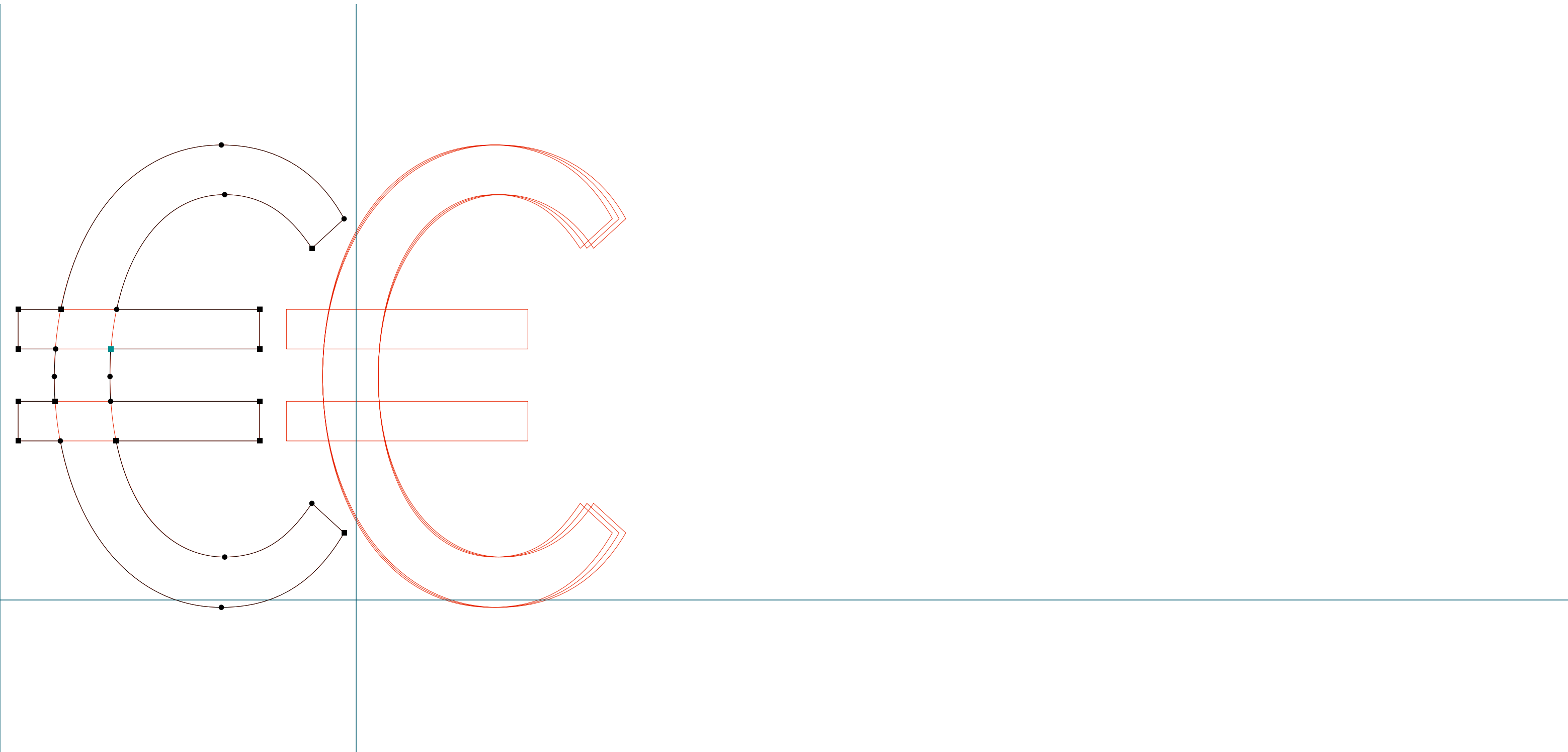

BASE 900

.....
Base900Sans L | fl | RoboFog Sketches | 2010 | Emigre Fonts

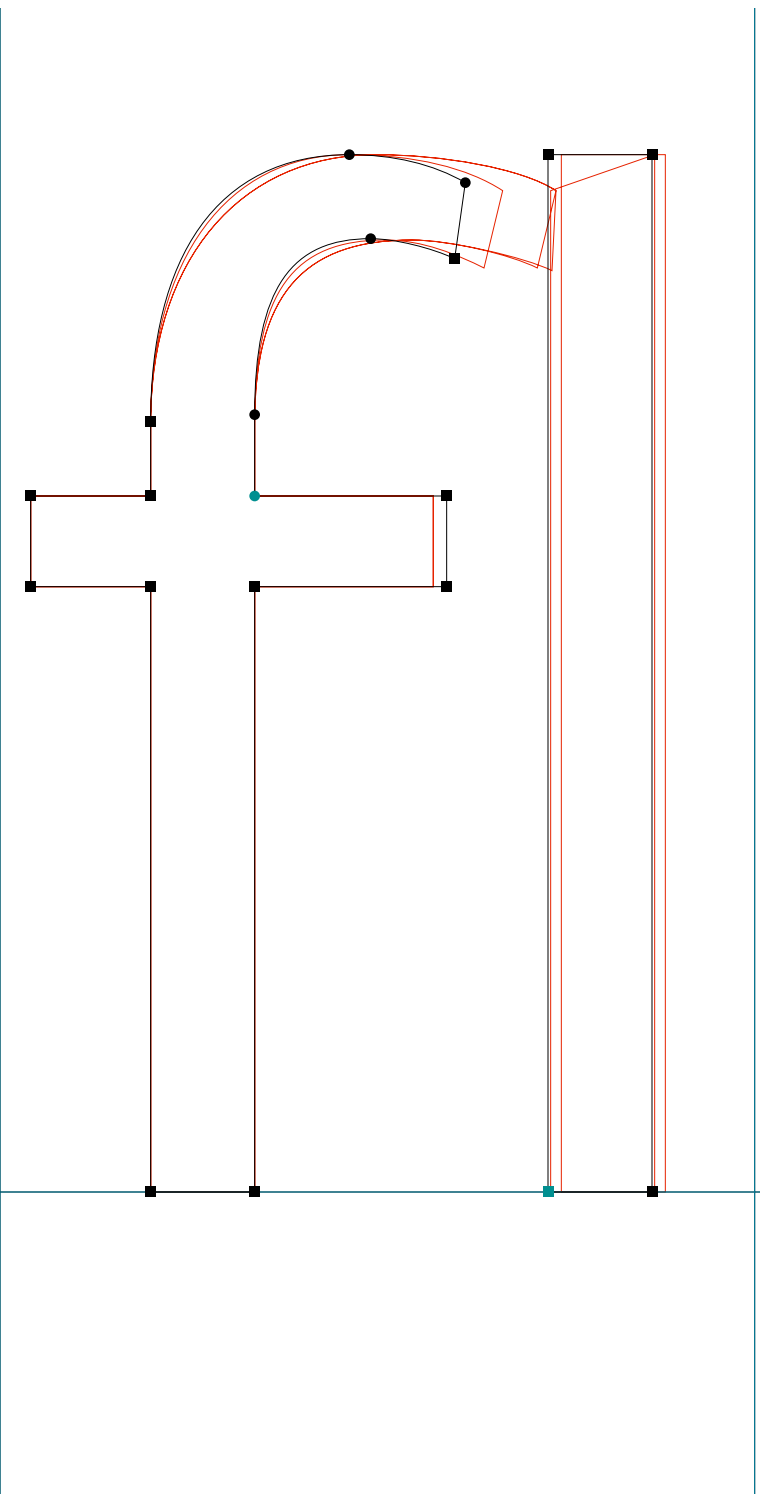

BASE 900

Base900Sans L | tilde | RoboFog Sketches | 2010 | Emigre Fonts

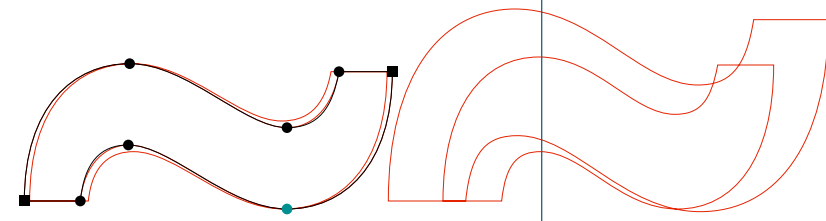

BASE 900

.....
Base900Sans R | DC4 | RoboFog Sketches | 2010 | Emigre Fonts

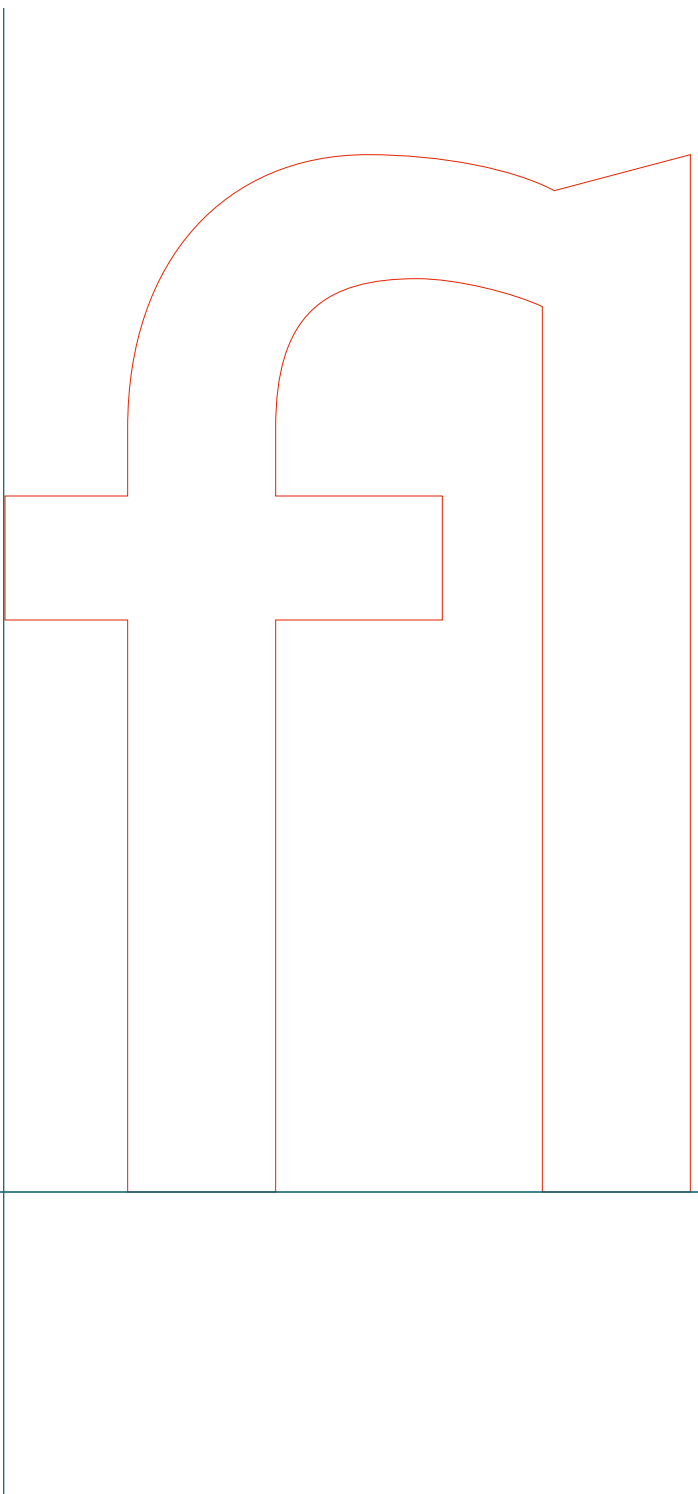
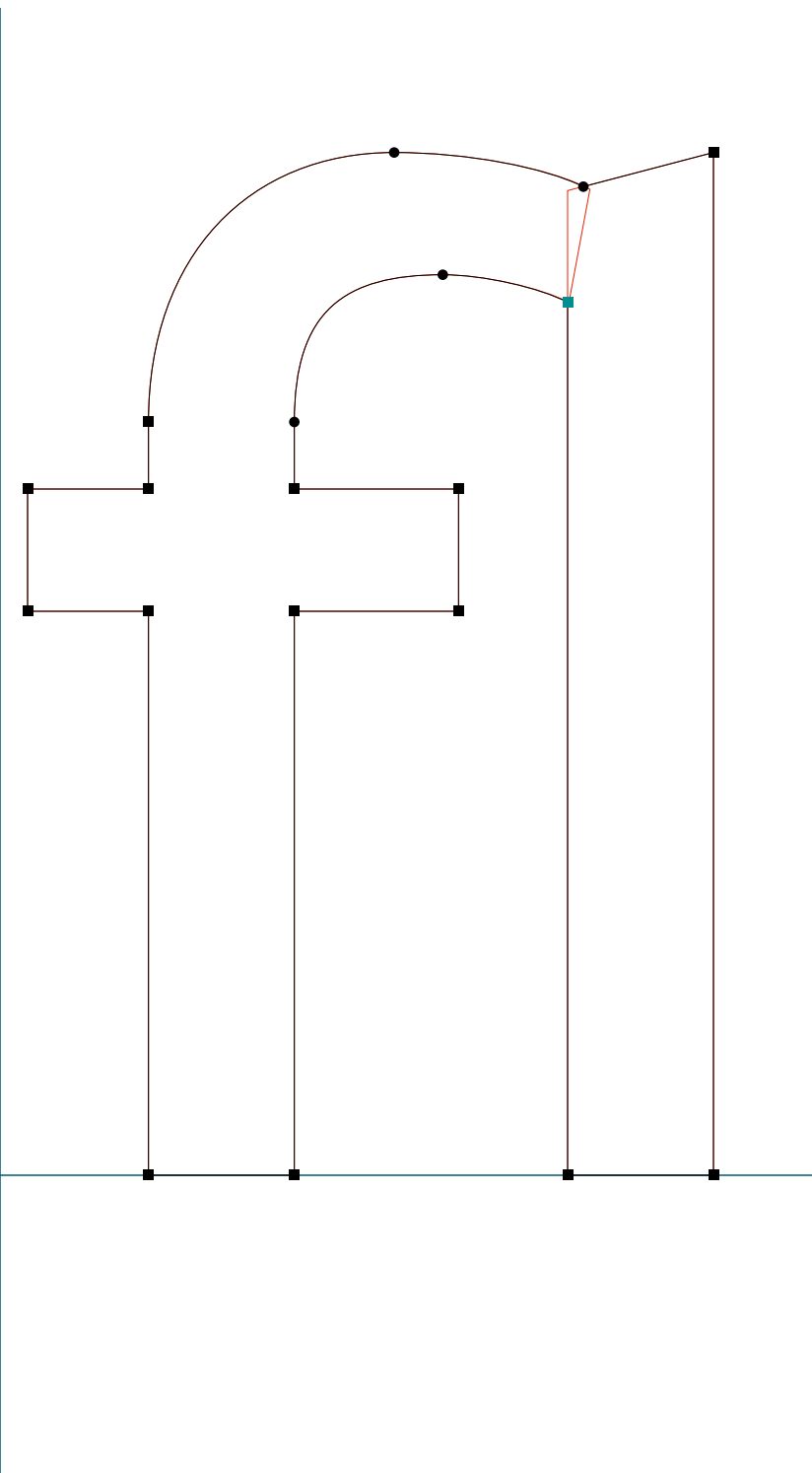

BASE 900

.....
Base900Sans R | three | RoboFog Sketches | 2010 | Emigre Fonts

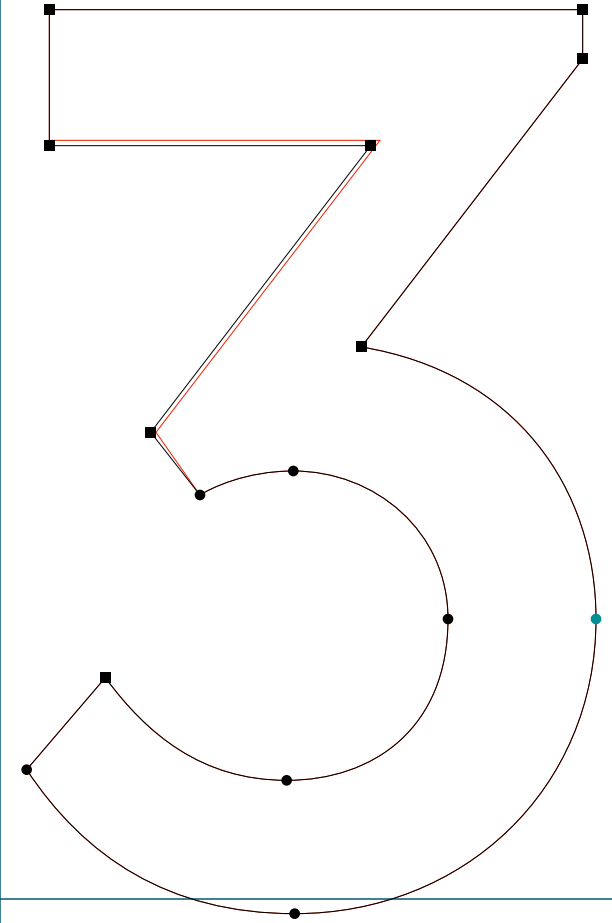

BASE 900

.....
Base900Sans R | five | RoboFog Sketches | 2010 | Emigre Fonts

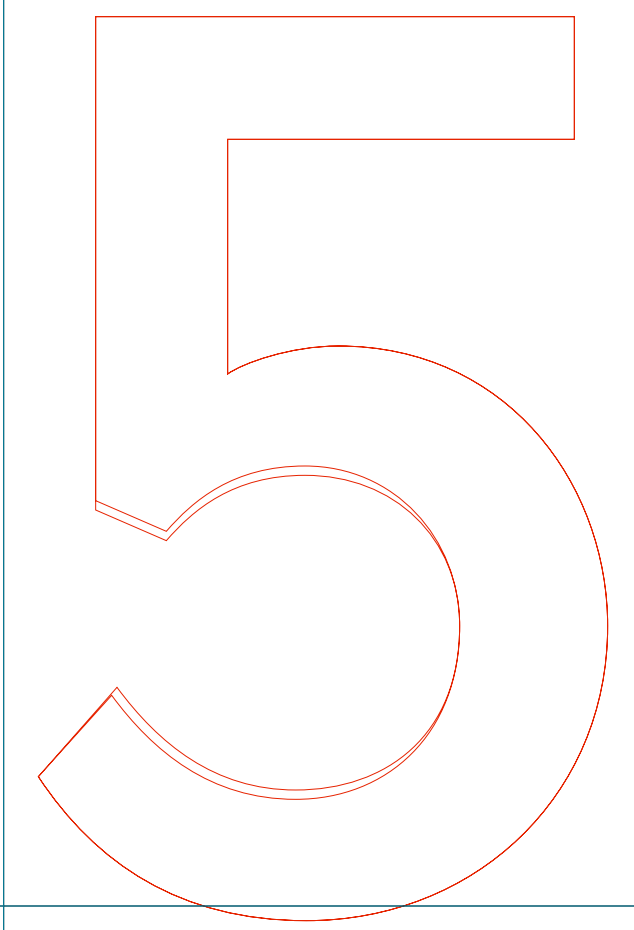
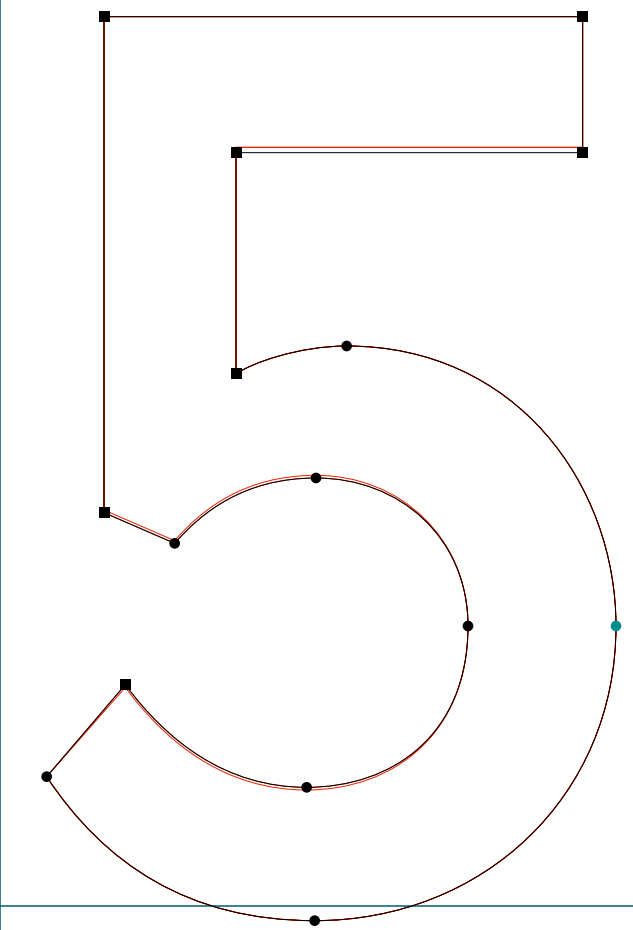

BASE 900

.....
Base900Sans R | six | RoboFog Sketches | 2010 | Emigre Fonts

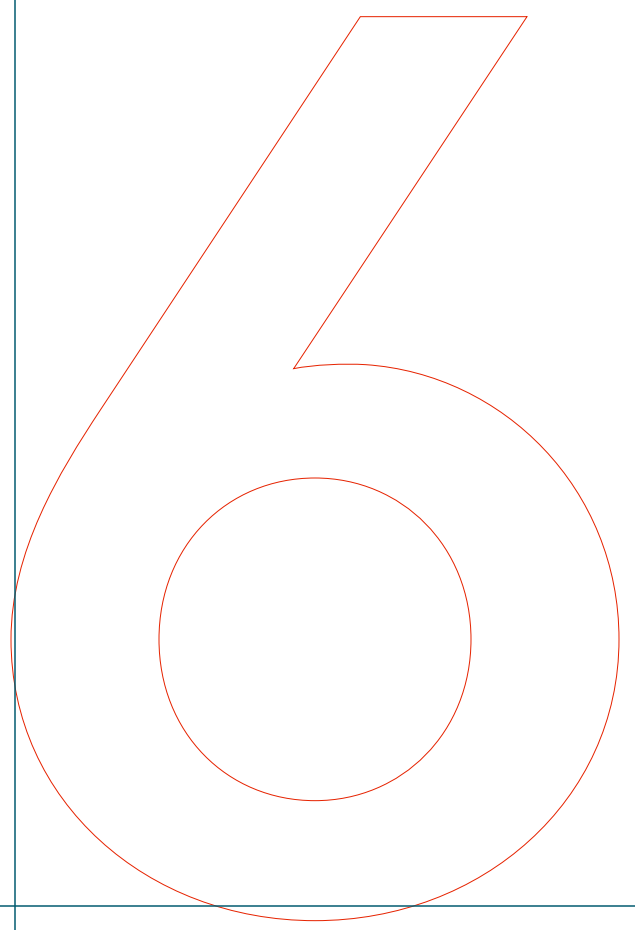
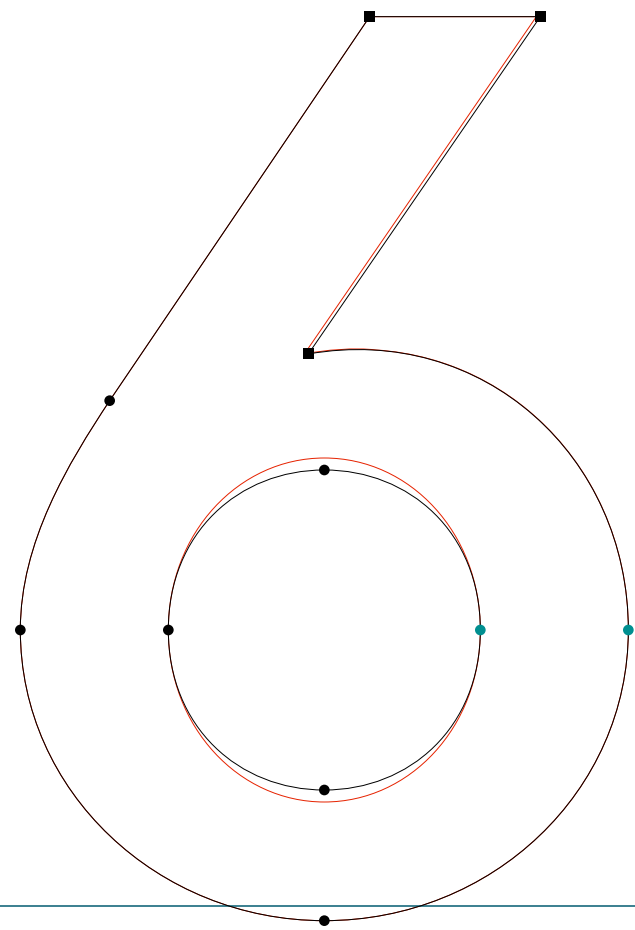

BASE 900

.....
Base900Sans R | G | RoboFog Sketches | 2010 | Emigre Fonts

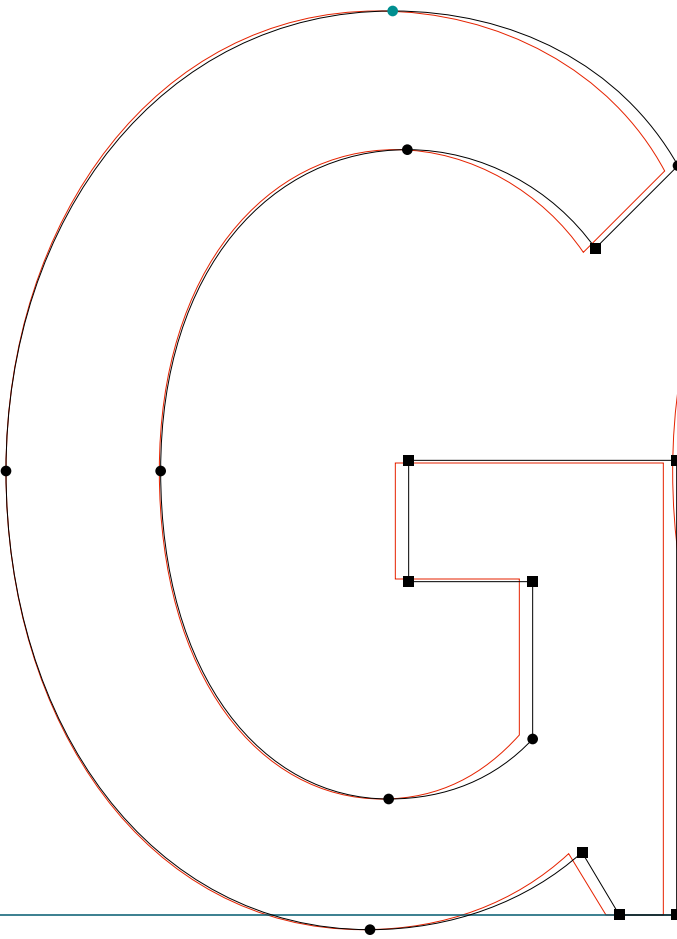

BASE 900

.....
Base900Sans R | J | RoboFog Sketches | 2010 | Emigre Fonts

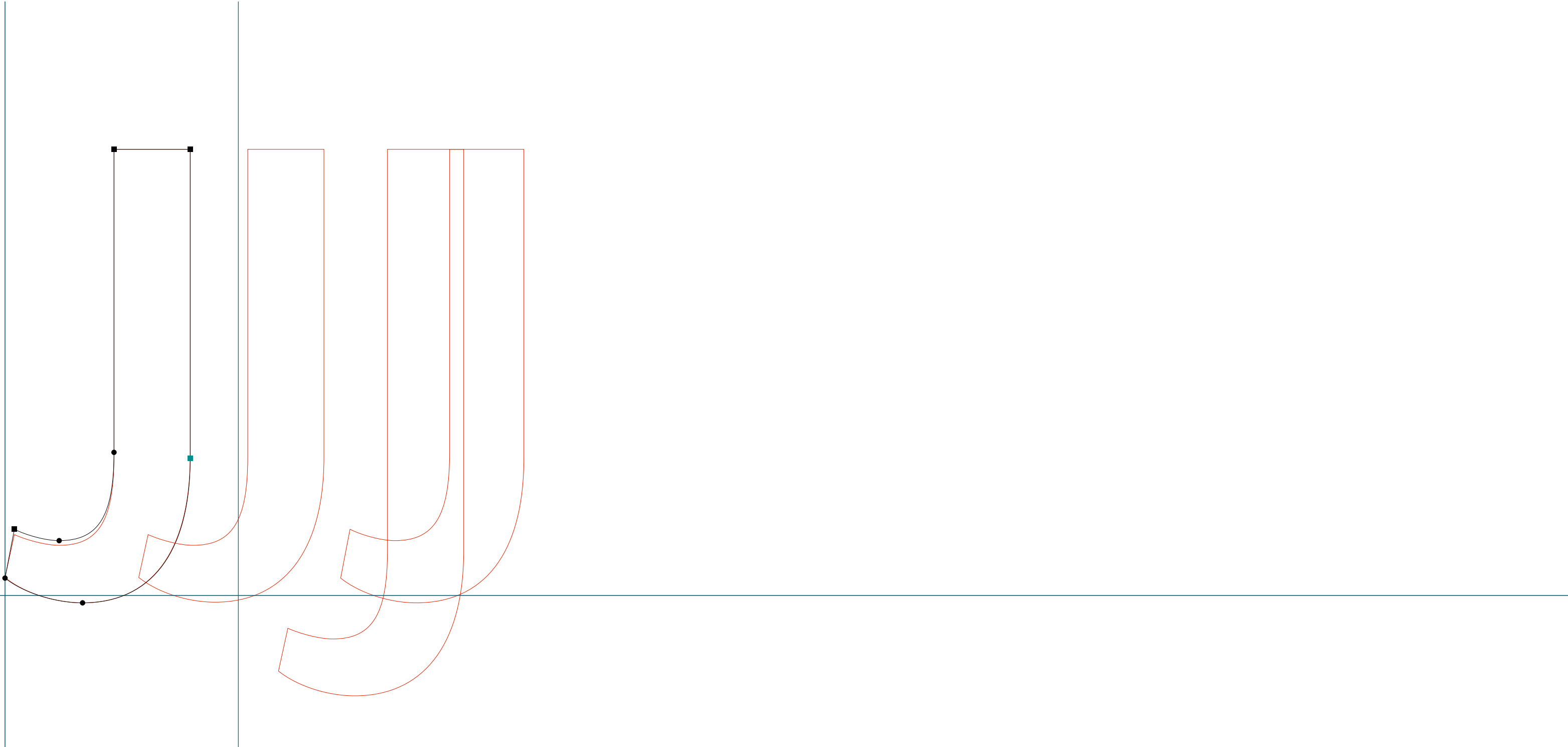

BASE 900

.....
Base900Sans R | Q | RoboFog Sketches | 2010 | Emigre Fonts

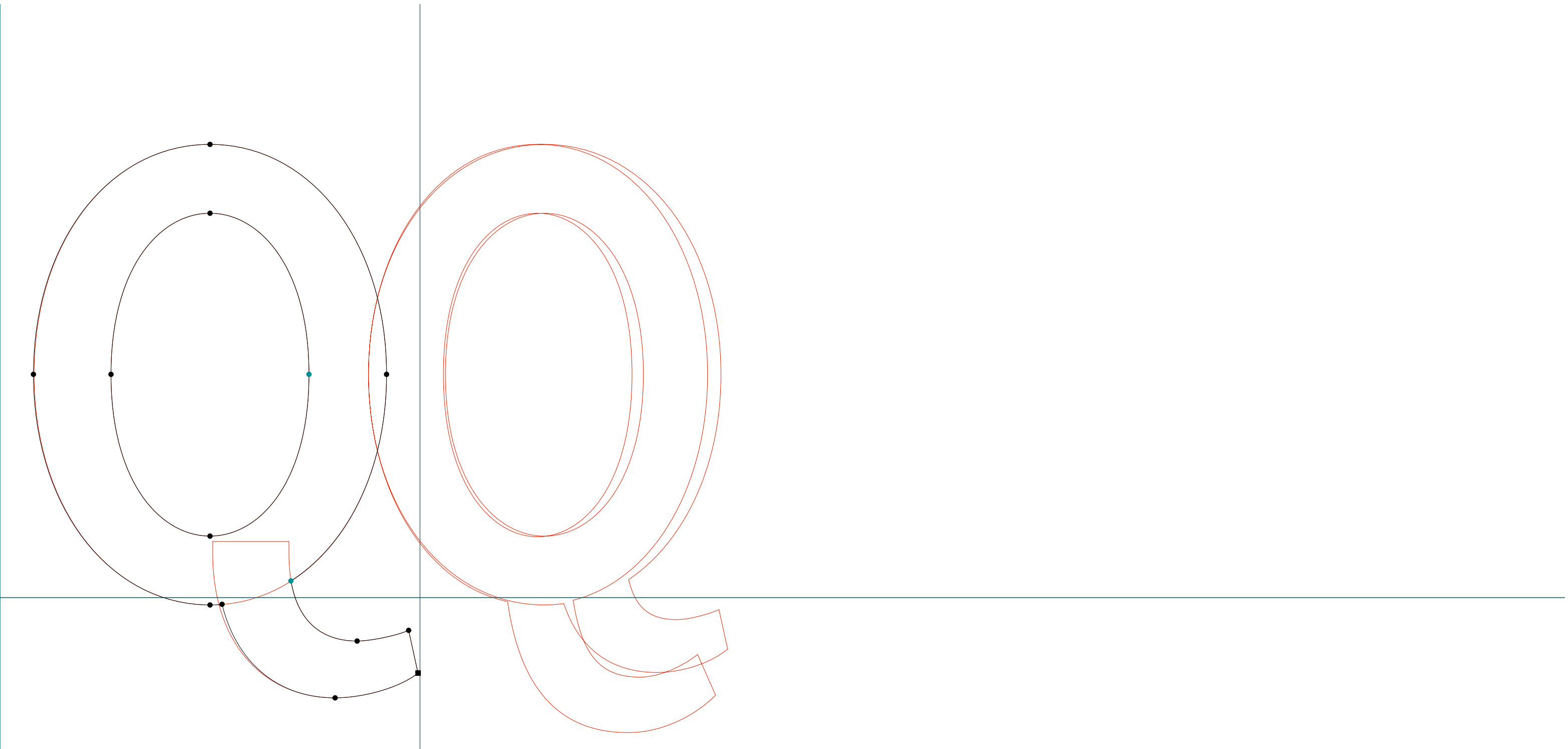

BASE 900

Base900Sans R | n | RoboFog Sketches | 2010 | Emigre Fonts

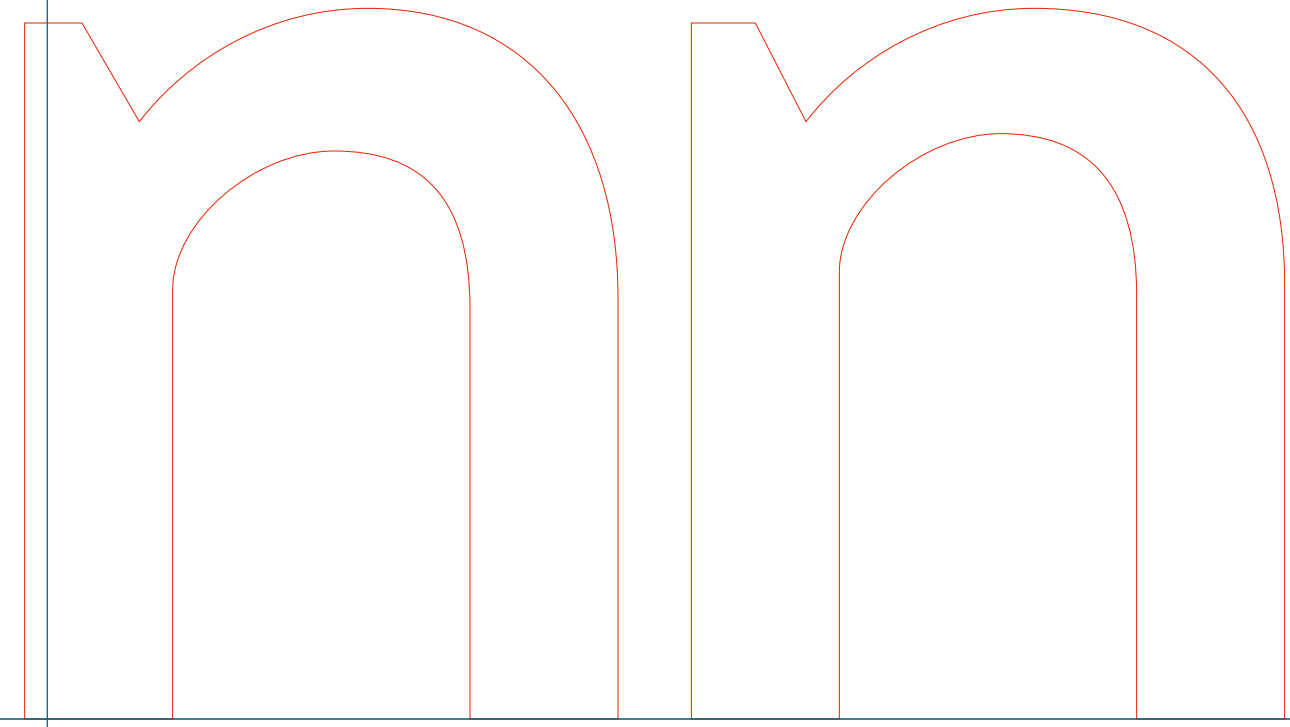
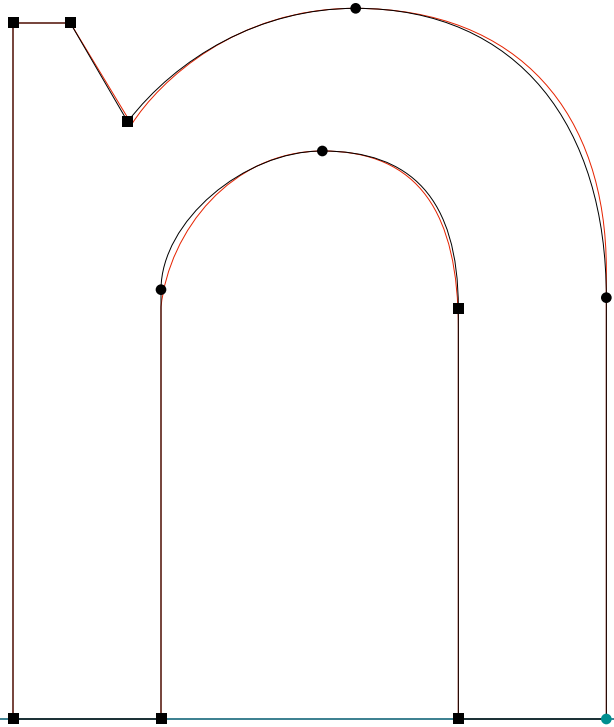

BASE 900

.....
Base900Sans R | r | RoboFog Sketches | 2010 | Emigre Fonts

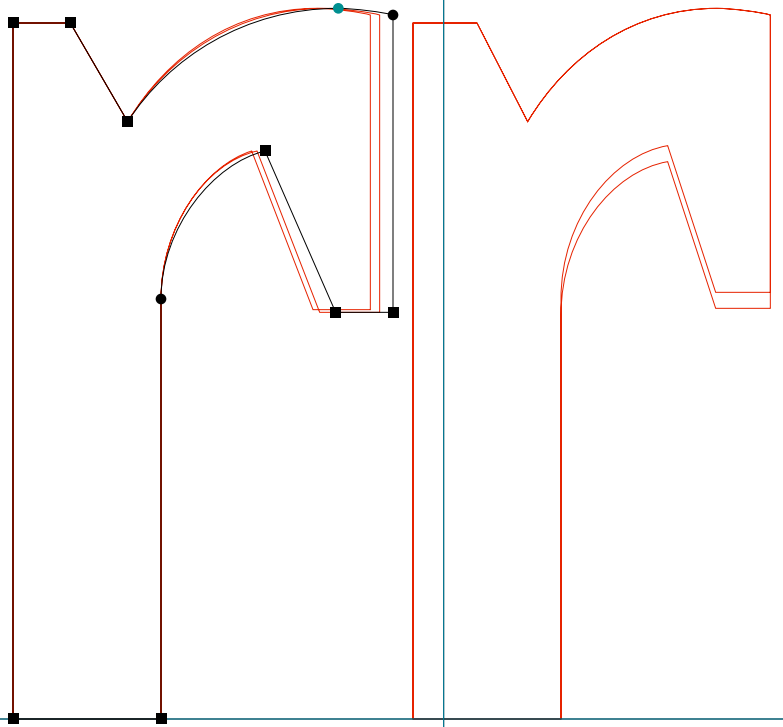

BASE 900

.....
Base900Sans R | s | RoboFog Sketches | 2010 | Emigre Fonts

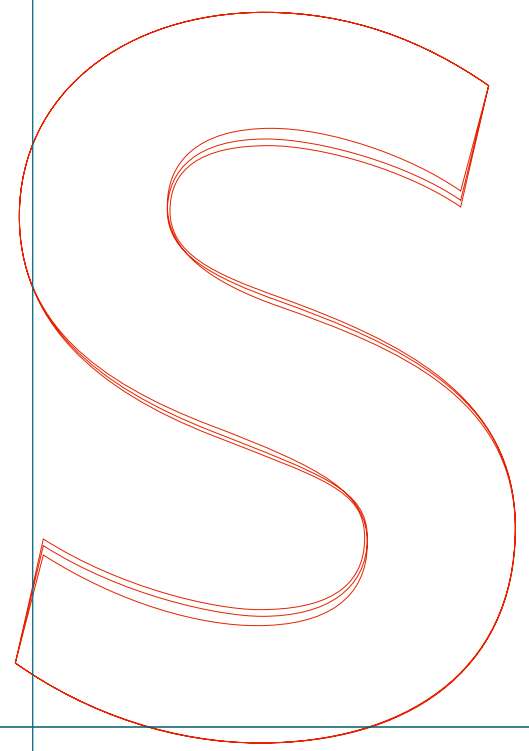
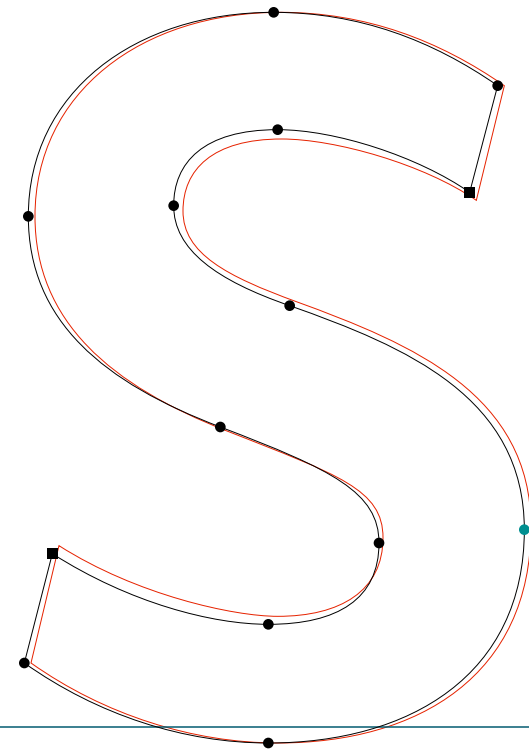

BASE 900

Base900Sans R | v | RoboFog Sketches | 2010 | Emigre Fonts

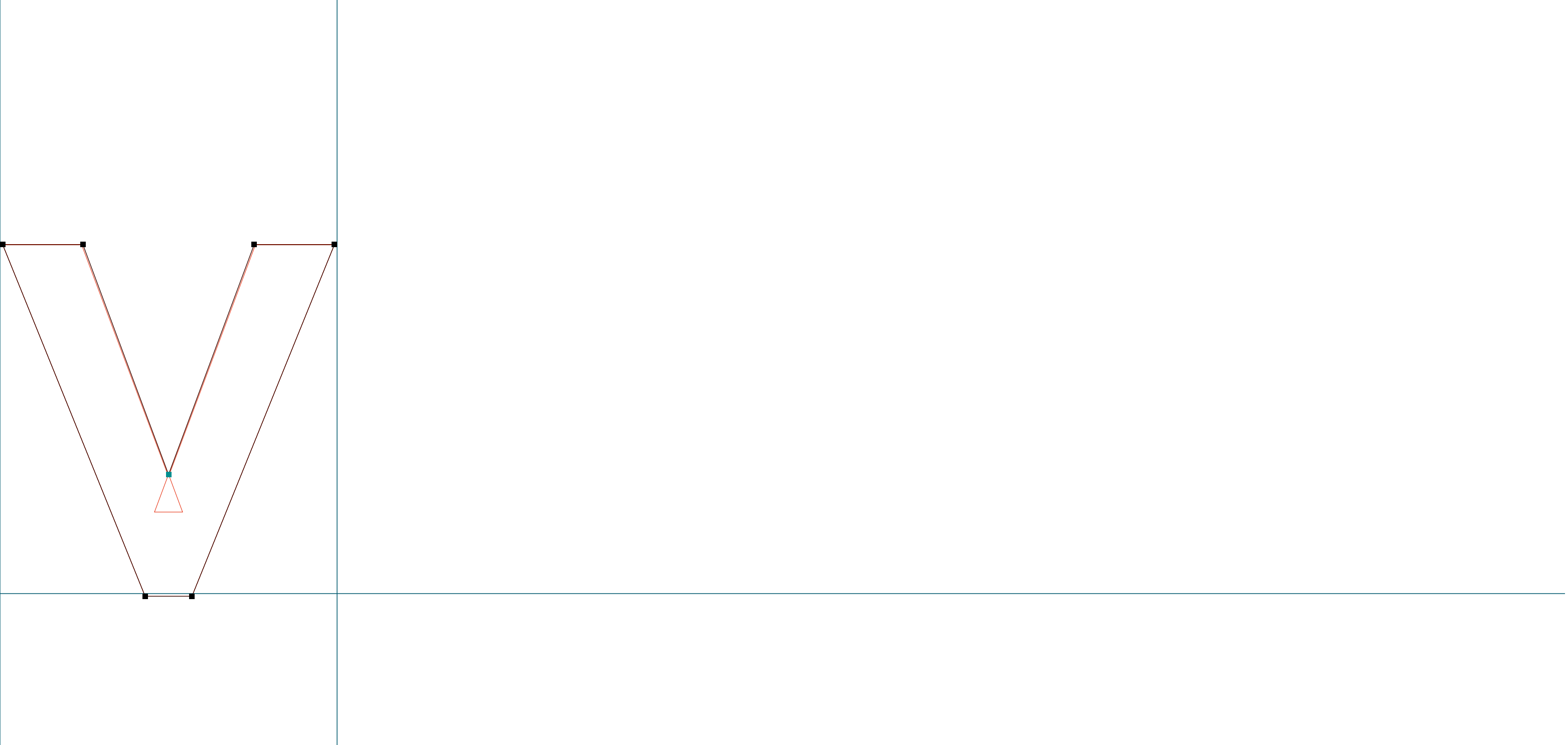

BASE 900

Base900Sans R | w | RoboFog Sketches | 2010 | Emigre Fonts

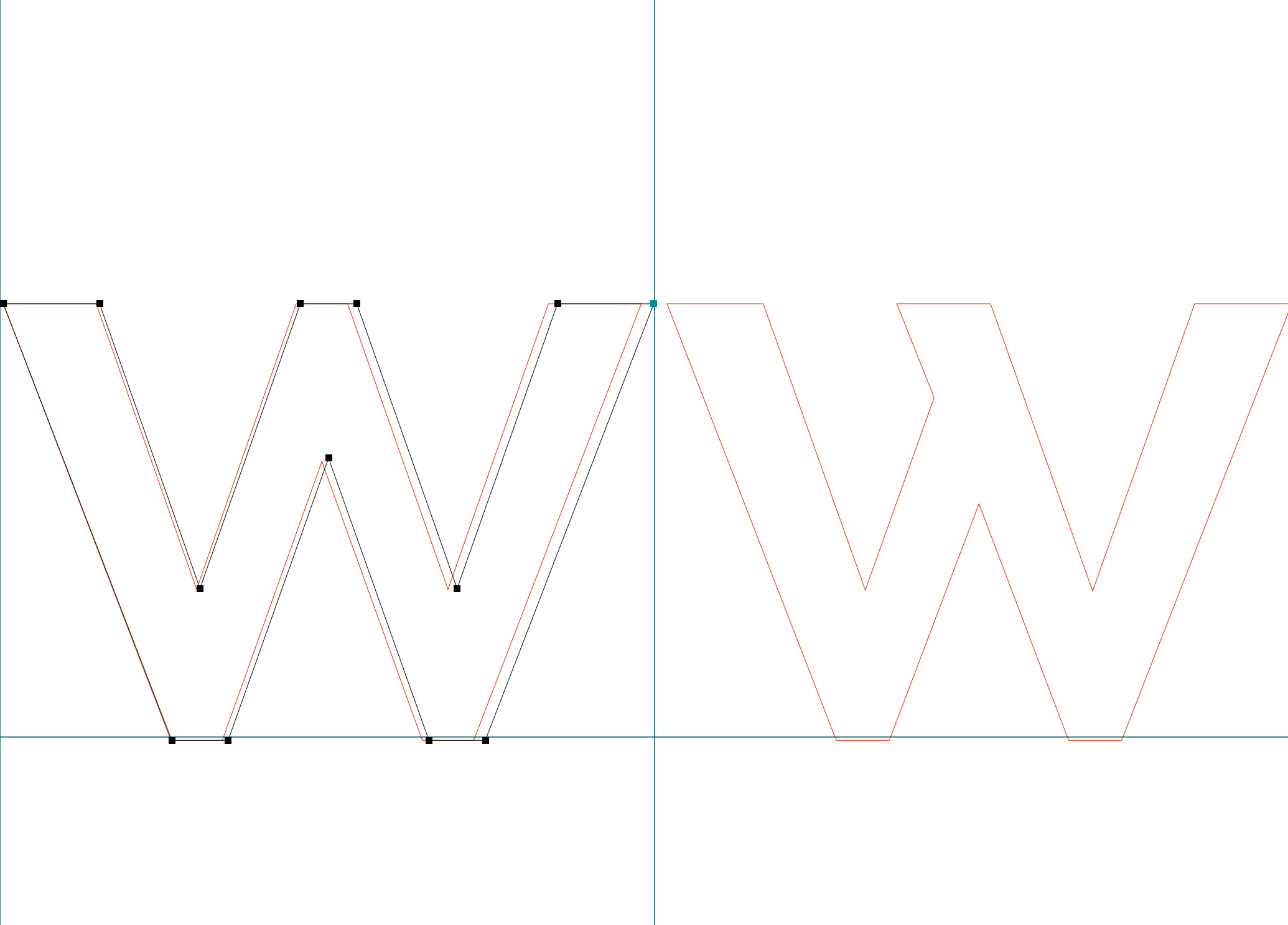

BASE 900

Base900Sans R | ae | RoboFog Sketches | 2010 | Emigre Fonts

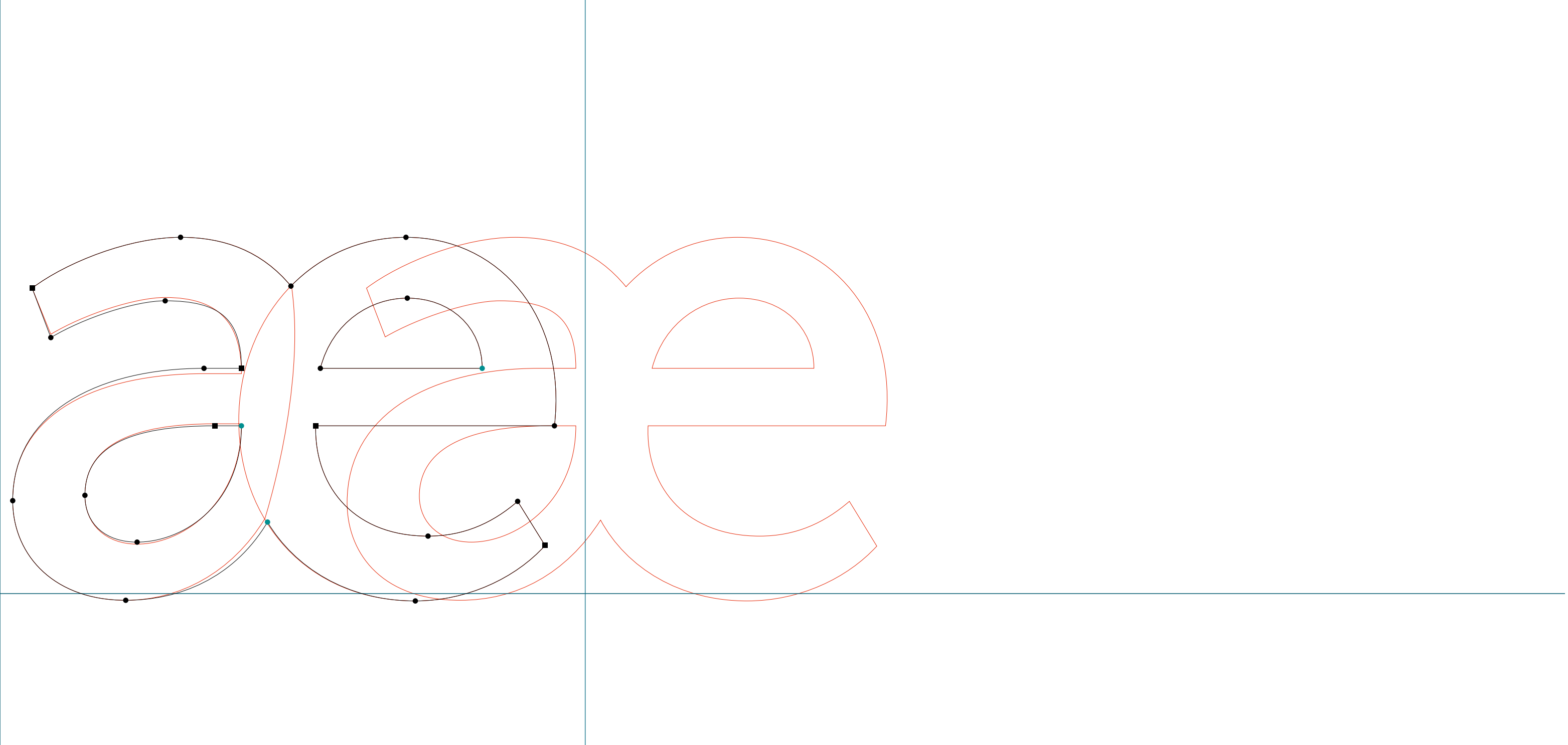

BASE 900

Base900Sans R | quoteright | RoboFog Sketches | 2010 | Emigre Fonts

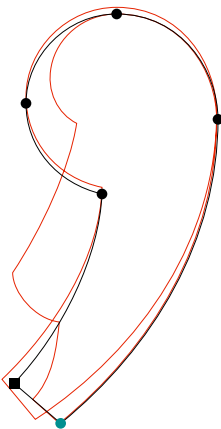

BASE 900

Base900Sans M | DC4 | RoboFog Sketches | 2010 | Emigre Fonts

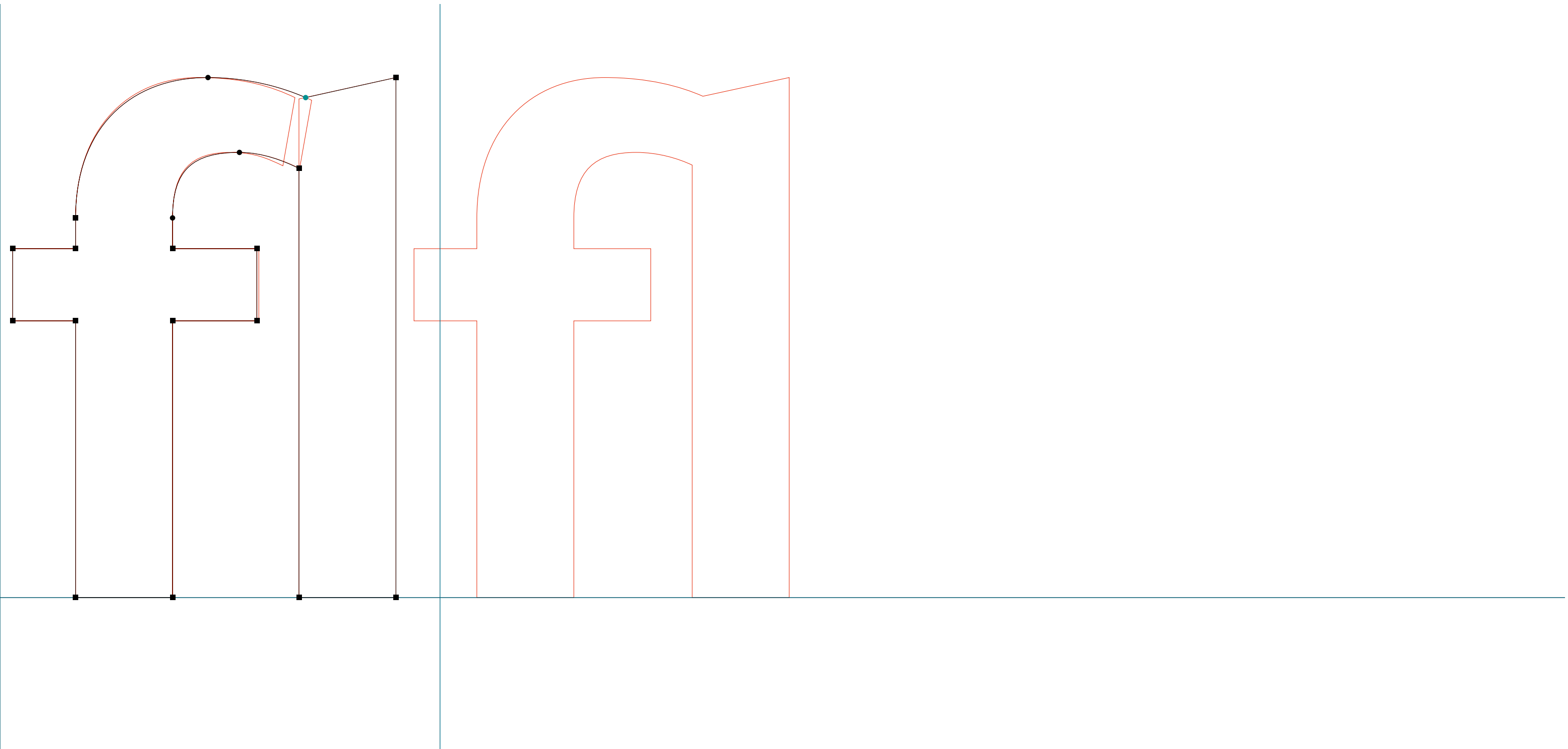

BASE 900

Base900Sans M | question | RoboFog Sketches | 2010 | Emigre Fonts

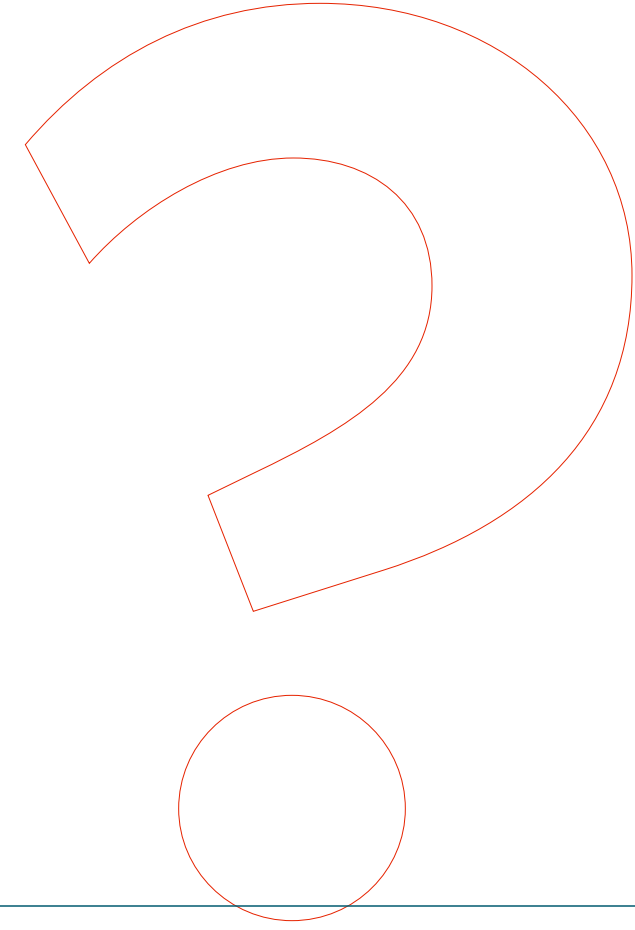
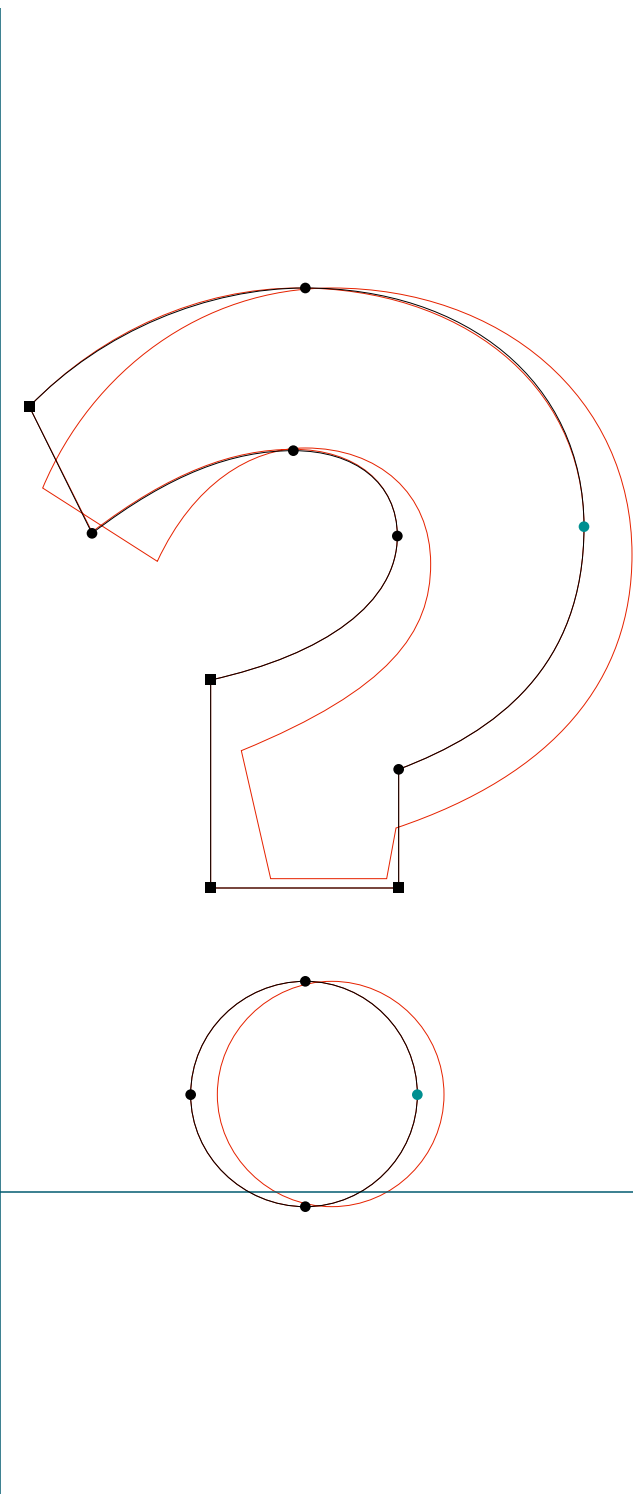

BASE 900

Base900Sans M | Q | RoboFog Sketches | 2010 | Emigre Fonts

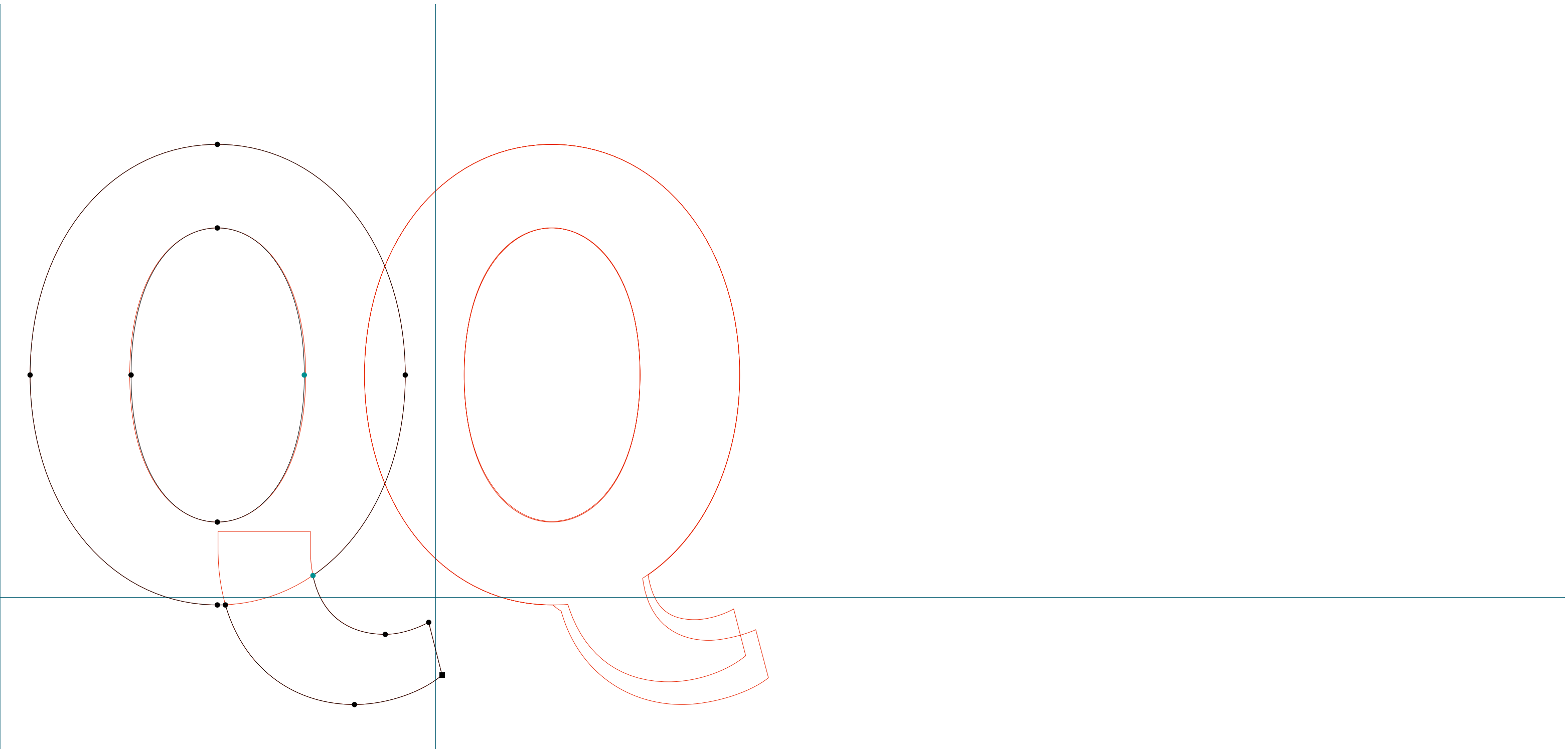

BASE 900

.....
Base900Sans M | Z | RoboFog Sketches | 2010 | Emigre Fonts

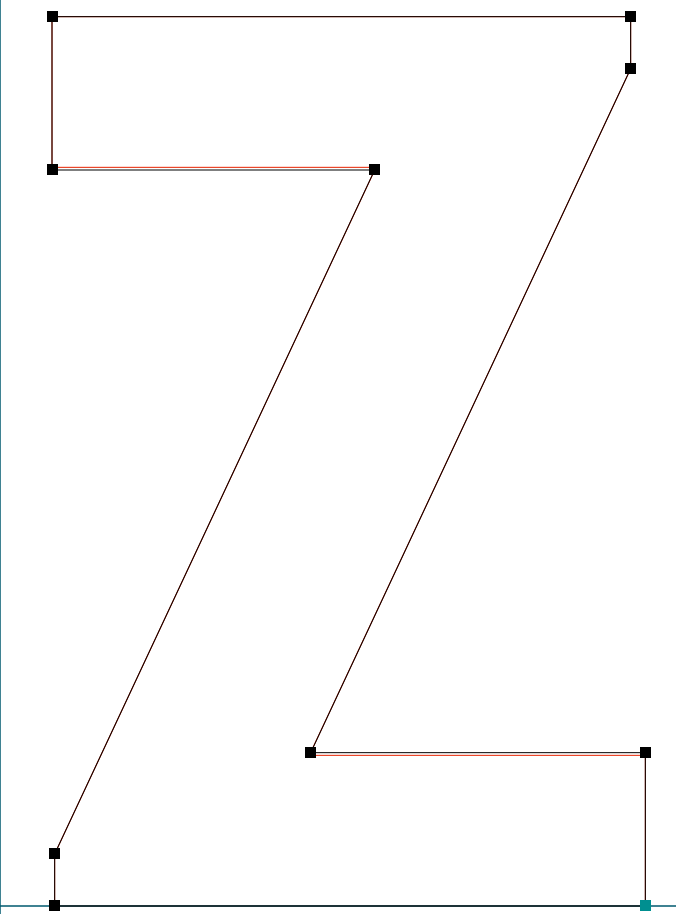

BASE 900

Base900Sans M | c | RoboFog Sketches | 2010 | Emigre Fonts

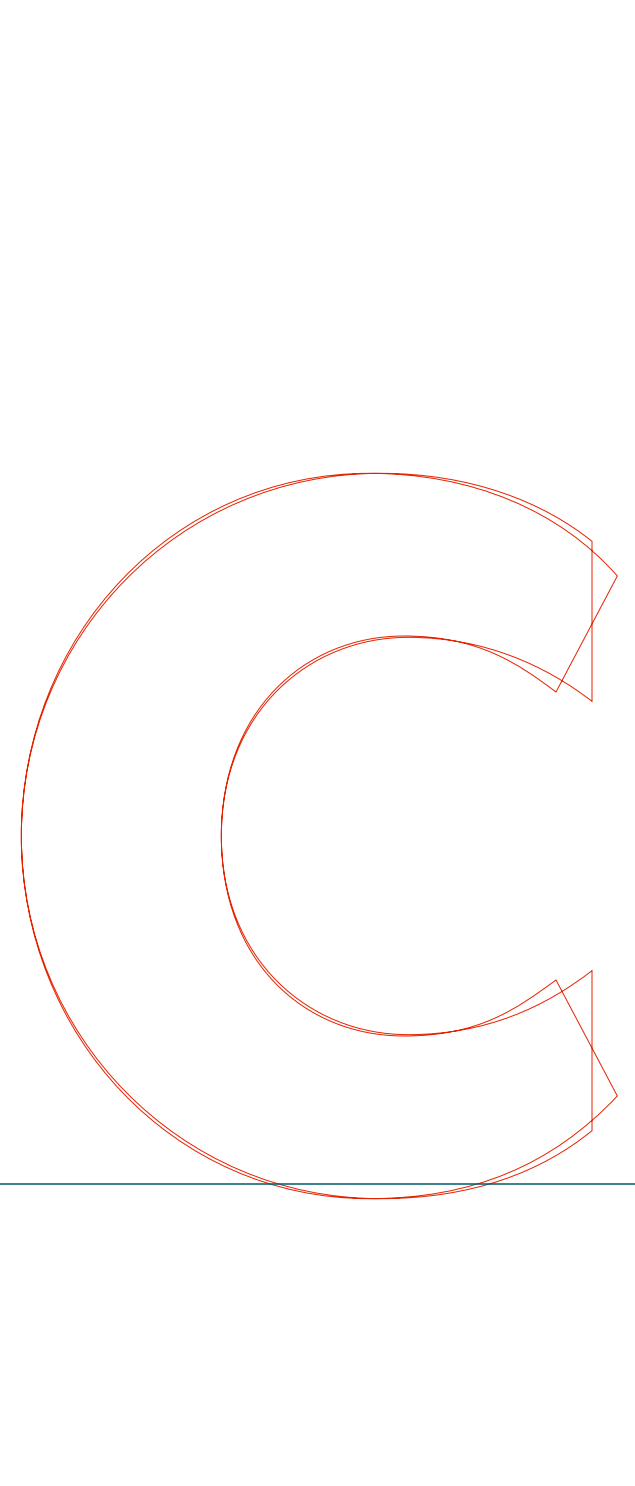
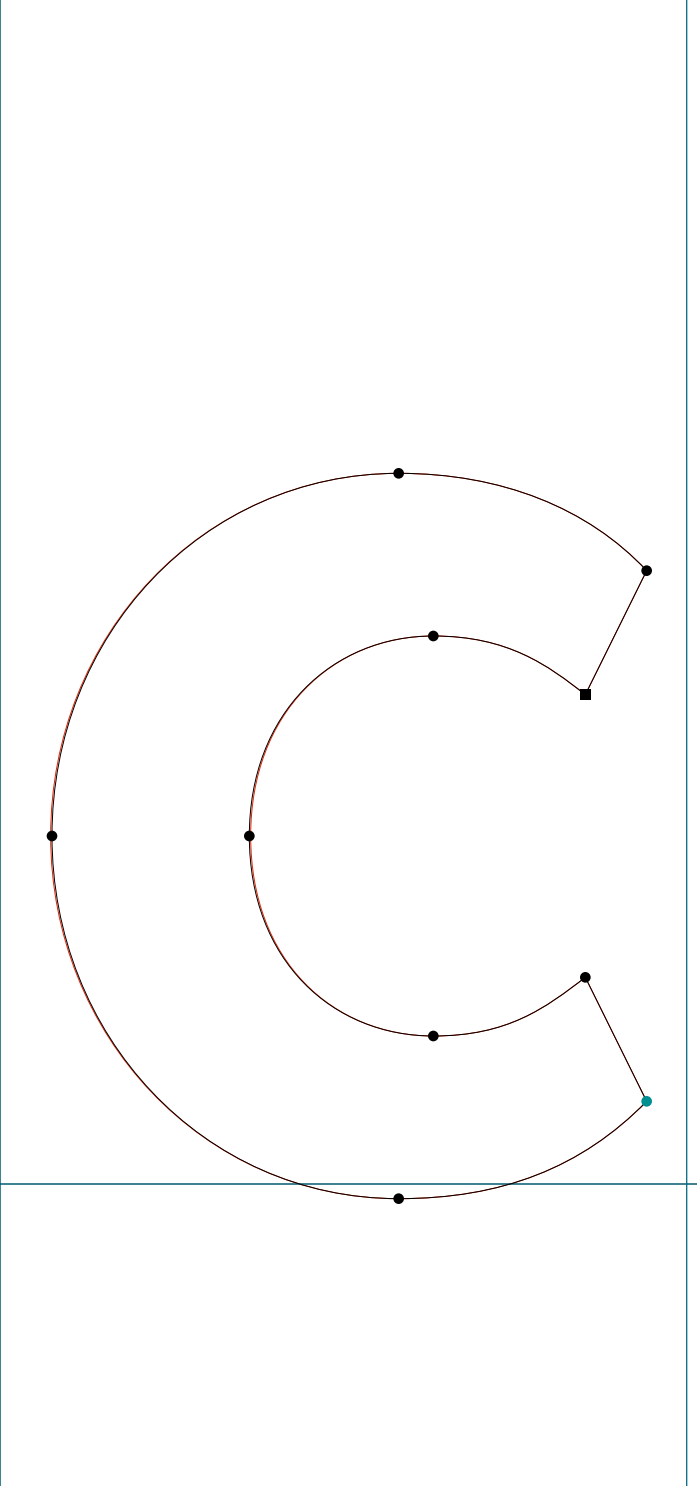

BASE 900

Base900Sans B | DC3 | RoboFog Sketches | 2010 | Emigre Fonts

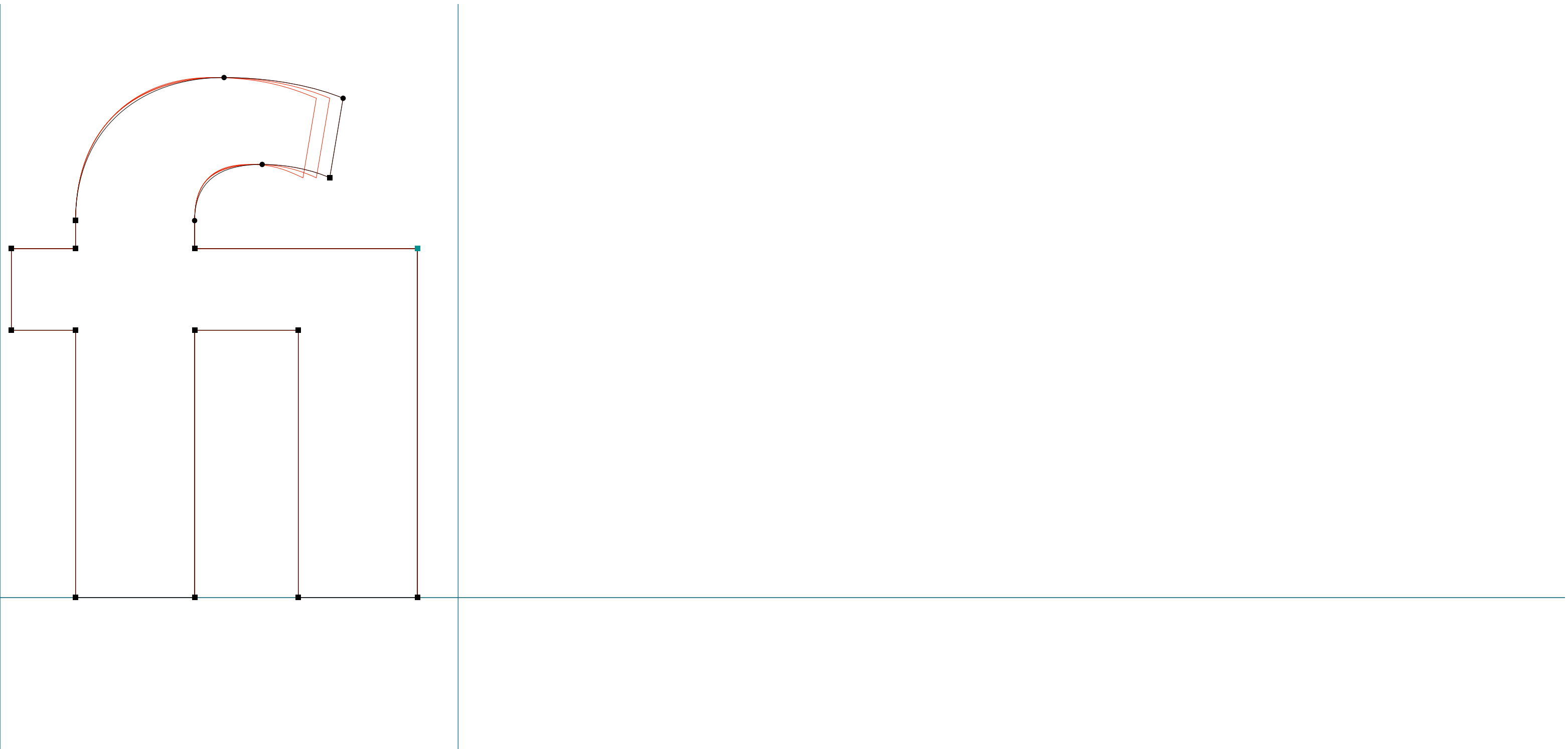

BASE 900

.....
Base900Sans B | dollar | RoboFog Sketches | 2010 | Emigre Fonts

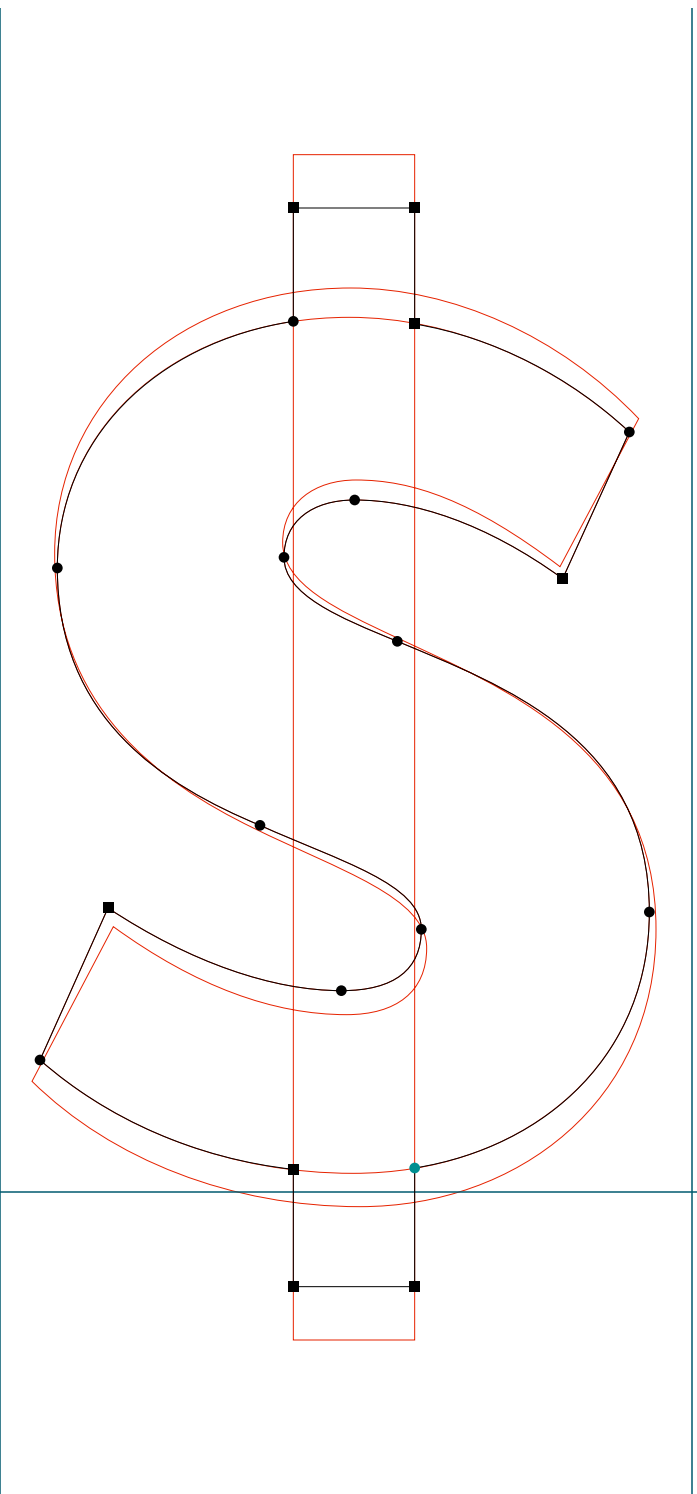

BASE 900

.....
Base900Sans B | ampersand | RoboFog Sketches | 2010 | Emigre Fonts

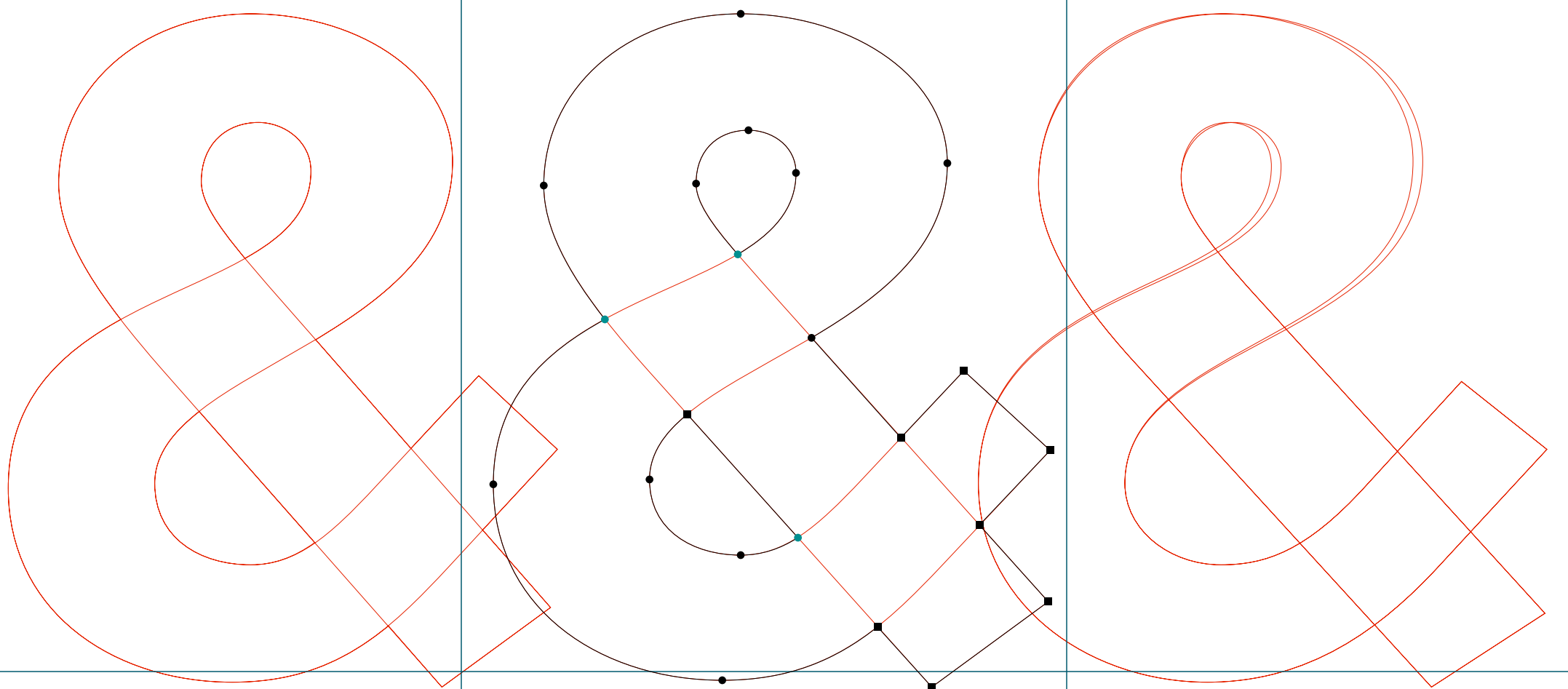

BASE 900

Base900Sans B | asterisk | RoboFog Sketches | 2010 | Emigre Fonts

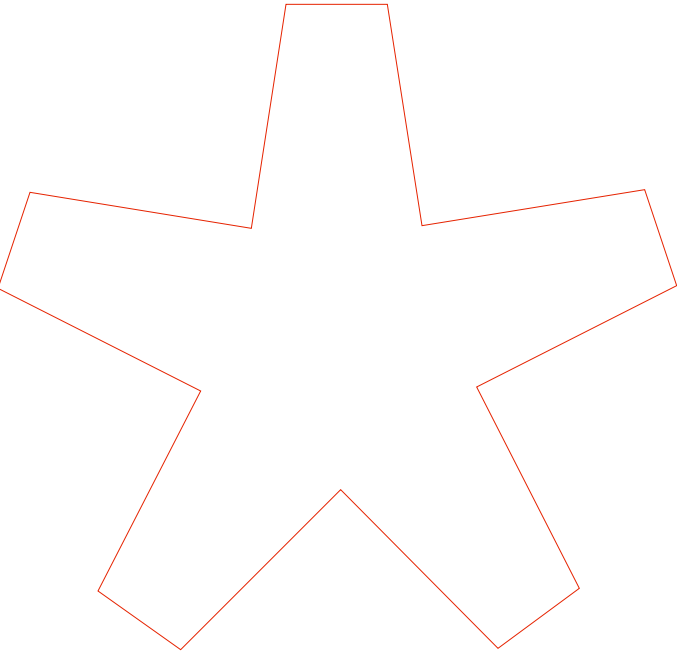
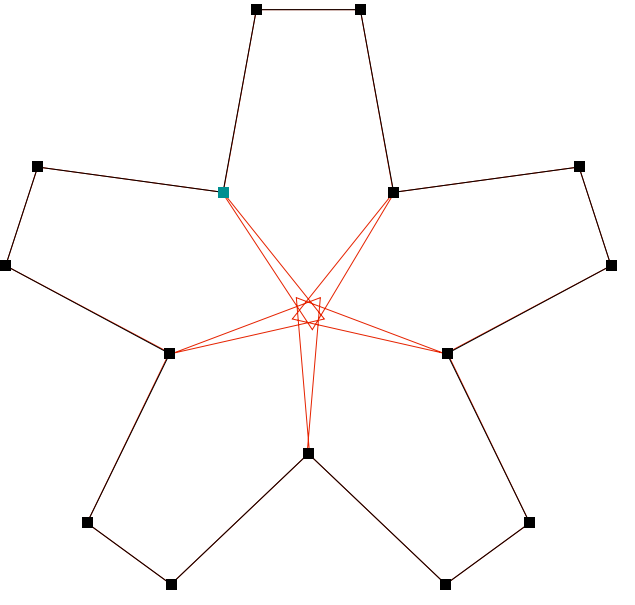
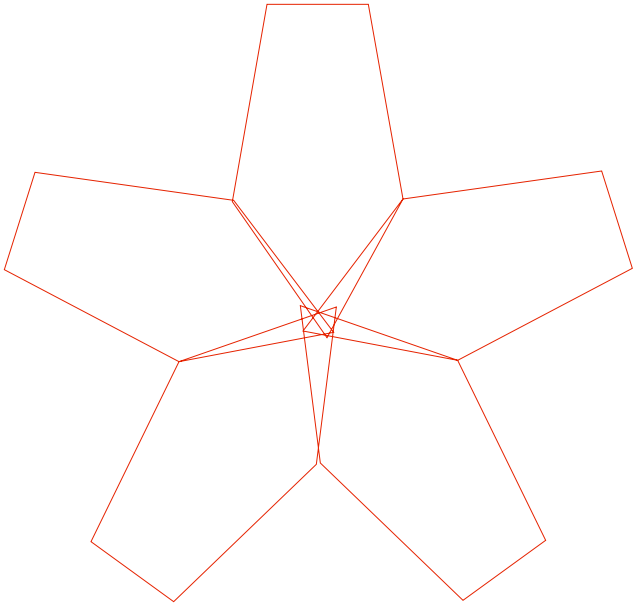

BASE 900

Base900Sans B | comma | RoboFog Sketches | 2010 | Emigre Fonts

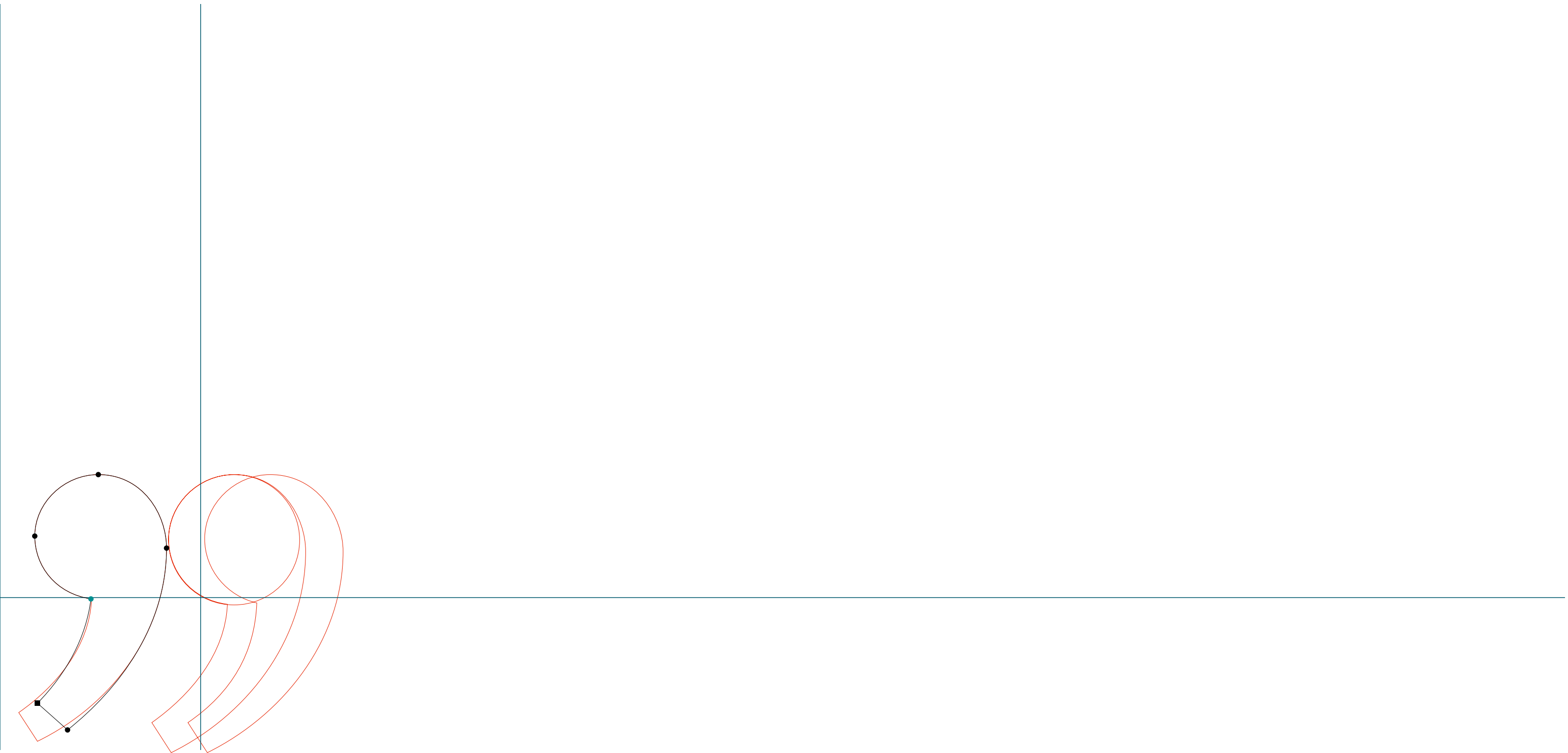

BASE 900

.....
Base900Sans B | two | RoboFog Sketches | 2010 | Emigre Fonts

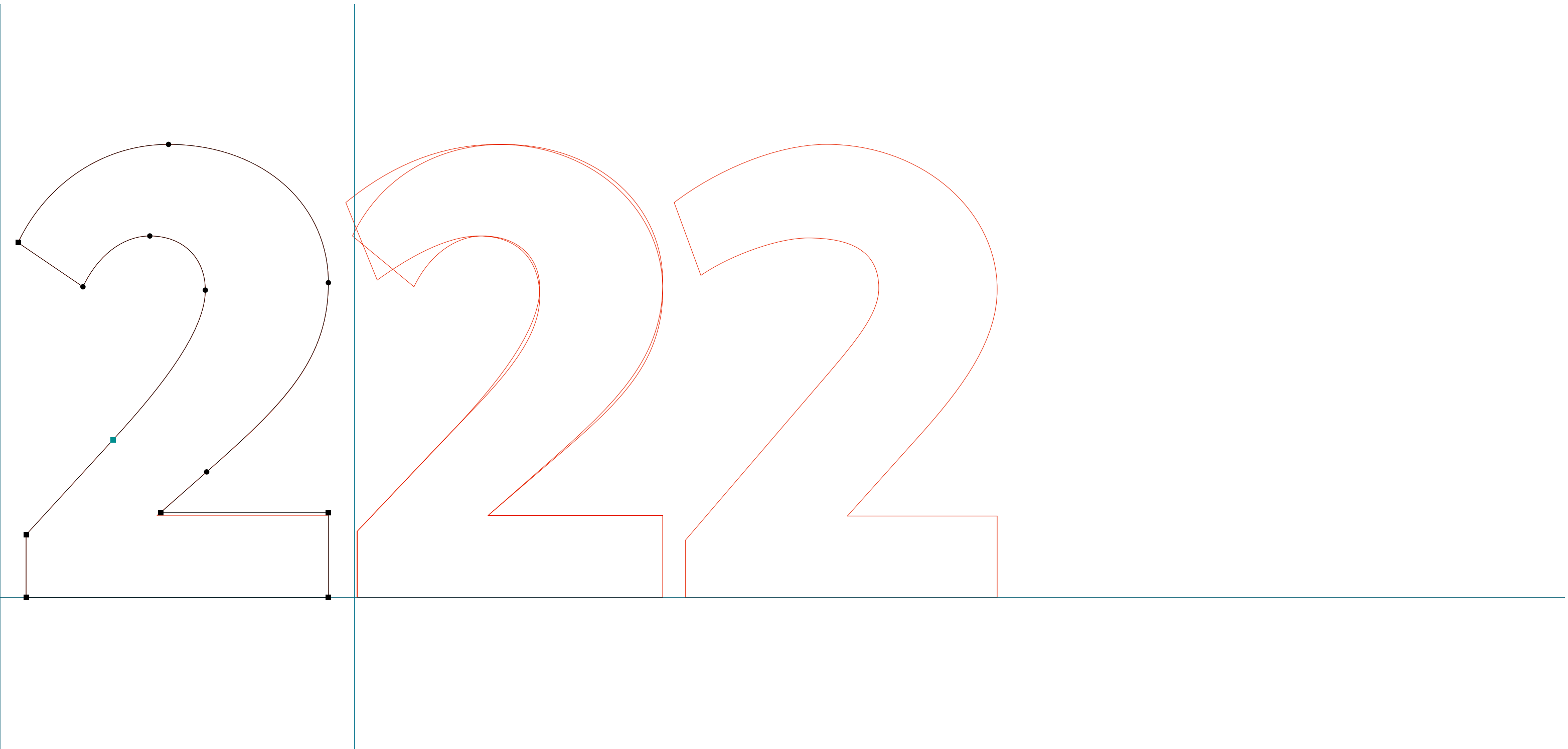

BASE 900

Base900Sans B | three | RoboFog Sketches | 2010 | Emigre Fonts



BASE 900

Base900Sans B | five | RoboFog Sketches | 2010 | Emigre Fonts

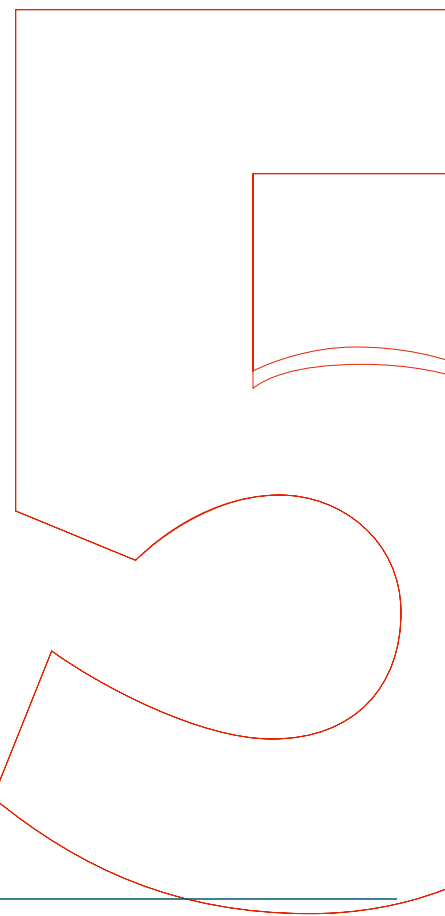
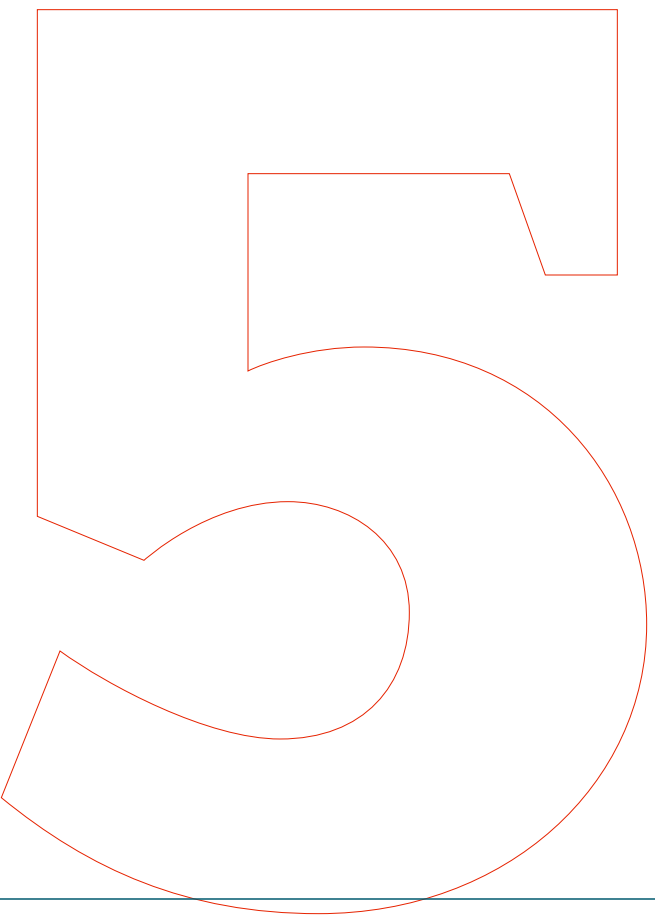
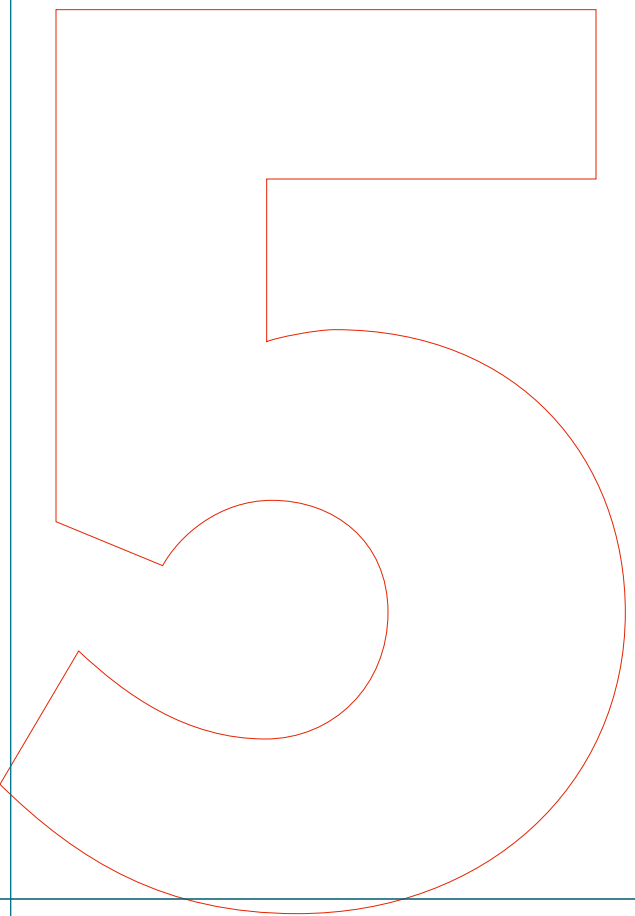
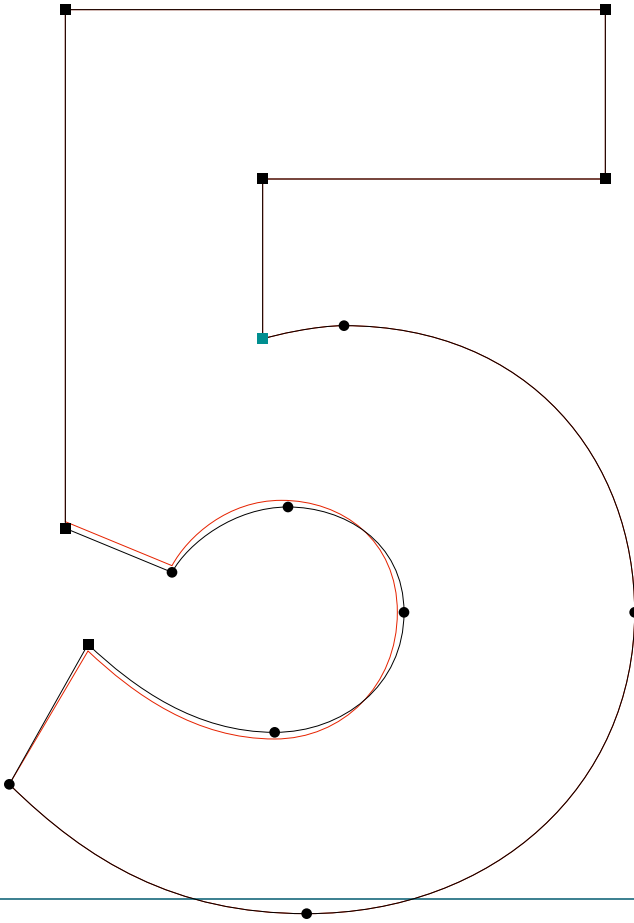
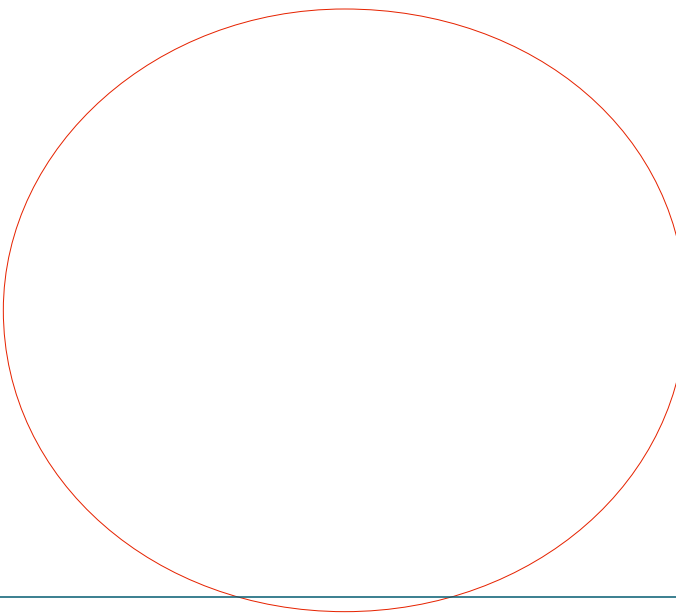

BASE 900

.....
Base900Sans B | six | RoboFog Sketches | 2010 | Emigre Fonts

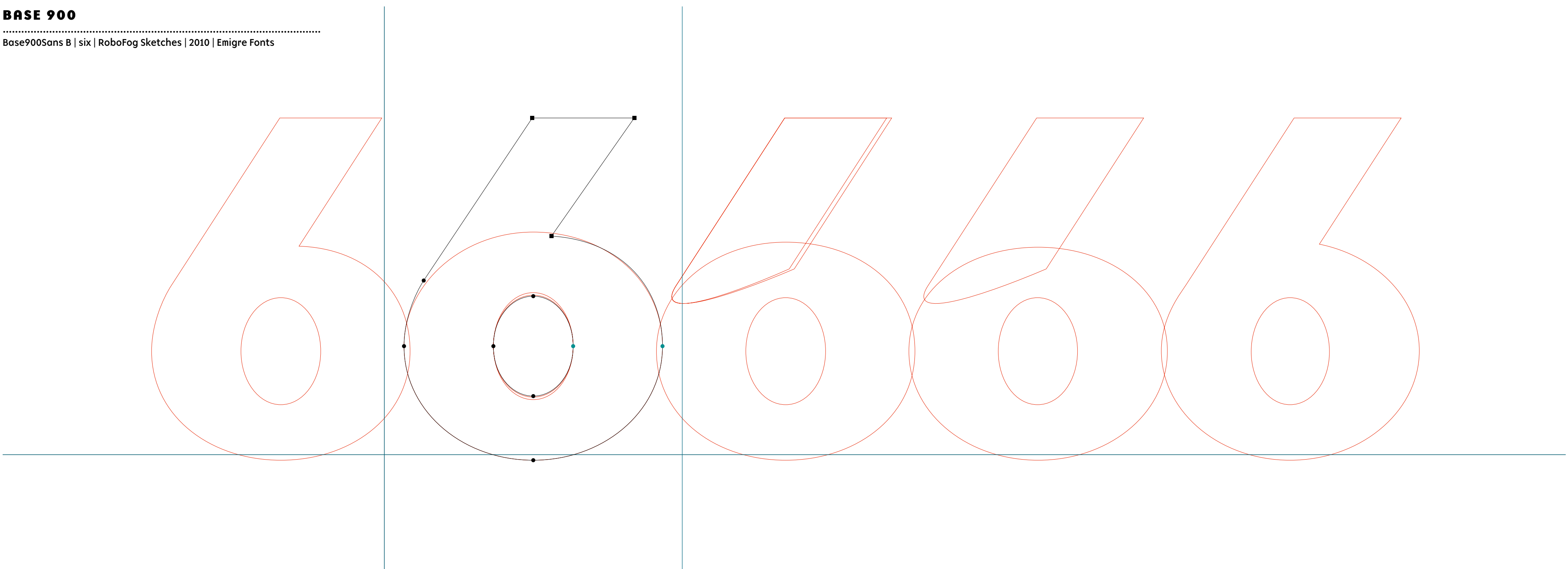

BASE 900

Base900Sans B | eight | RoboFog Sketches | 2010 | Emigre Fonts

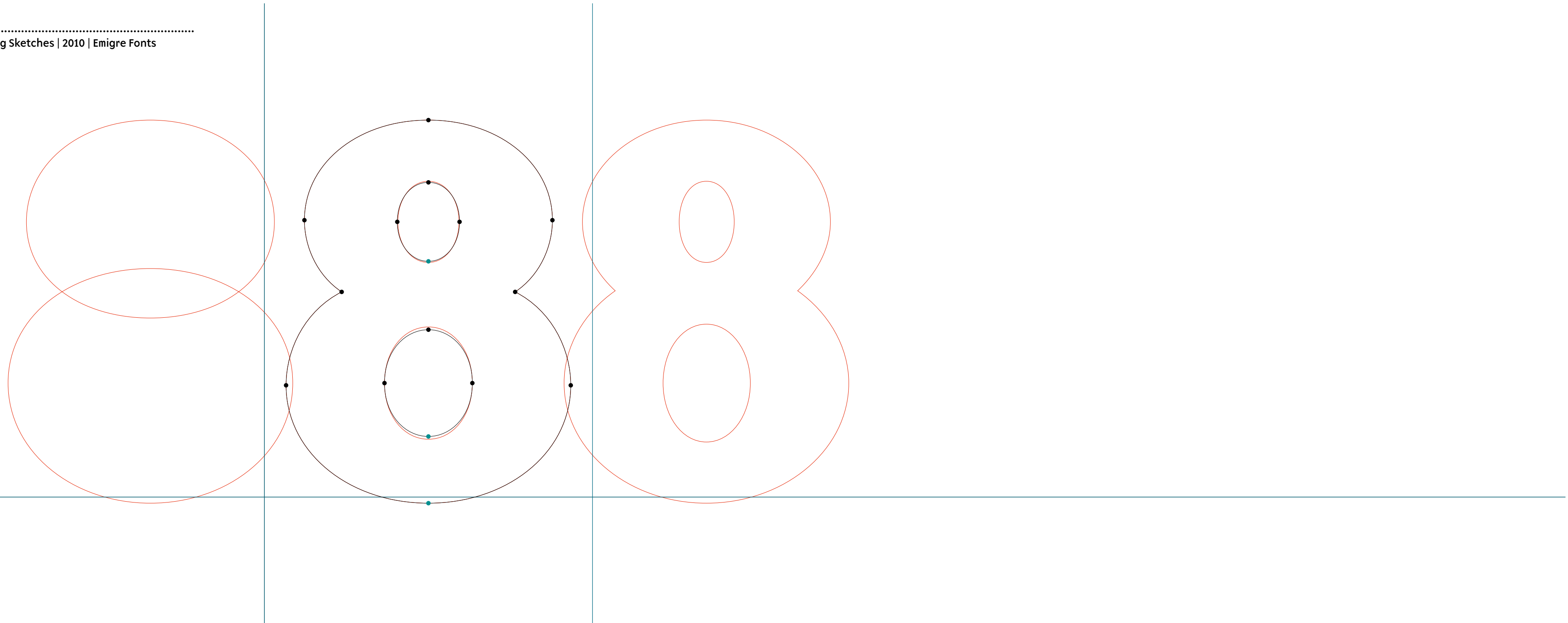

BASE 900

.....
Base900Sans B | nine | RoboFog Sketches | 2010 | Emigre Fonts

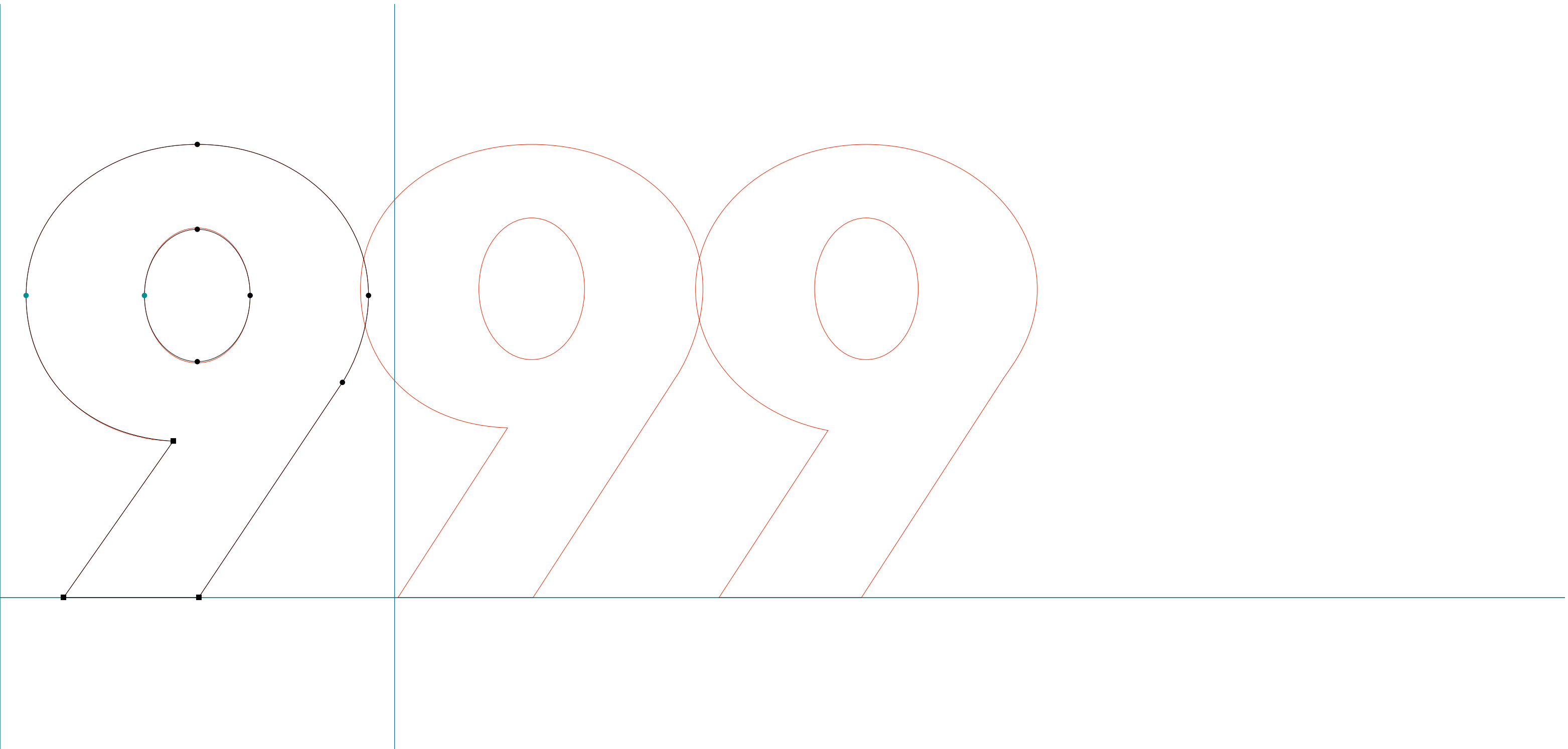

BASE 900

Base900Sans B | question | RoboFog Sketches | 2010 | Emigre Fonts

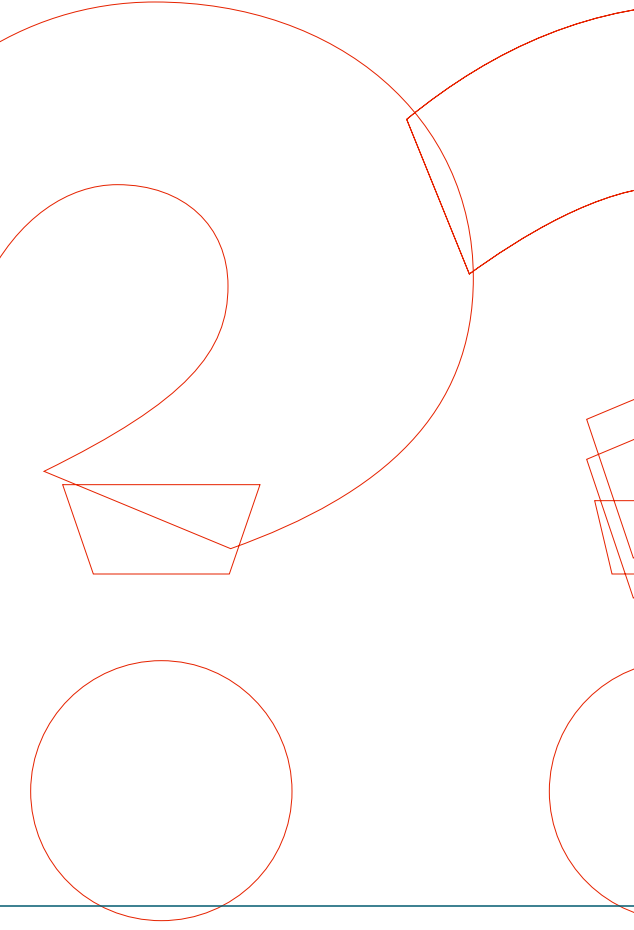
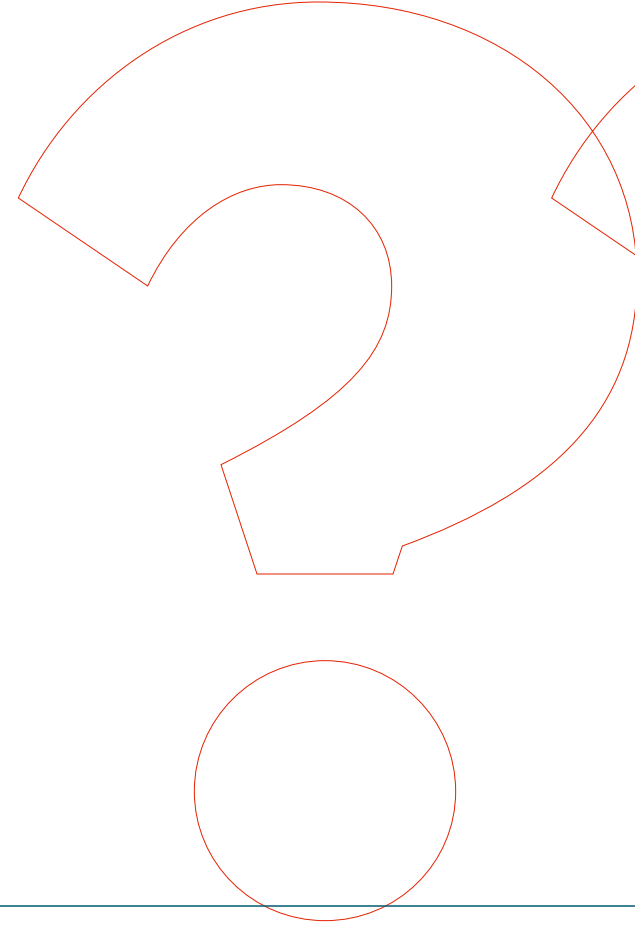
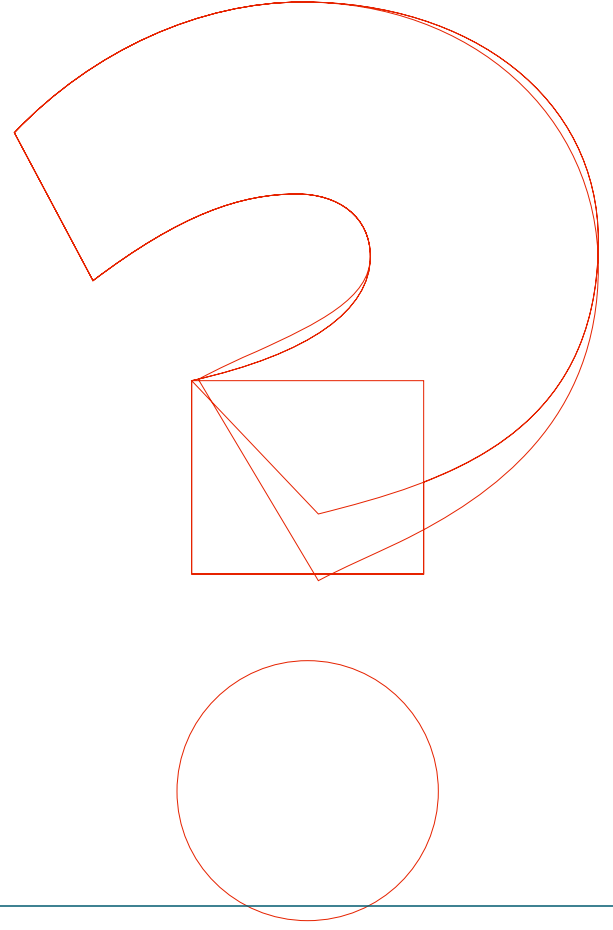
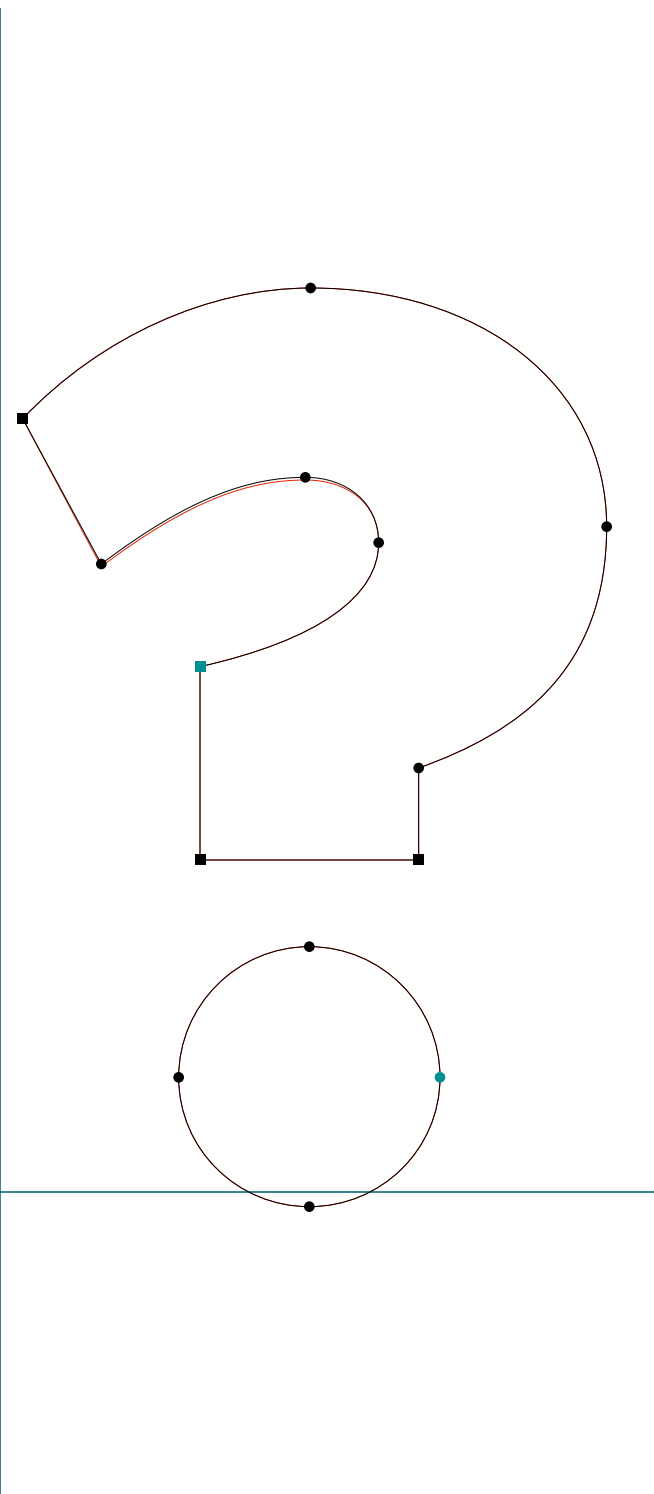

BASE 900

Base900Sans B | B | RoboFog Sketches | 2010 | Emigre Fonts

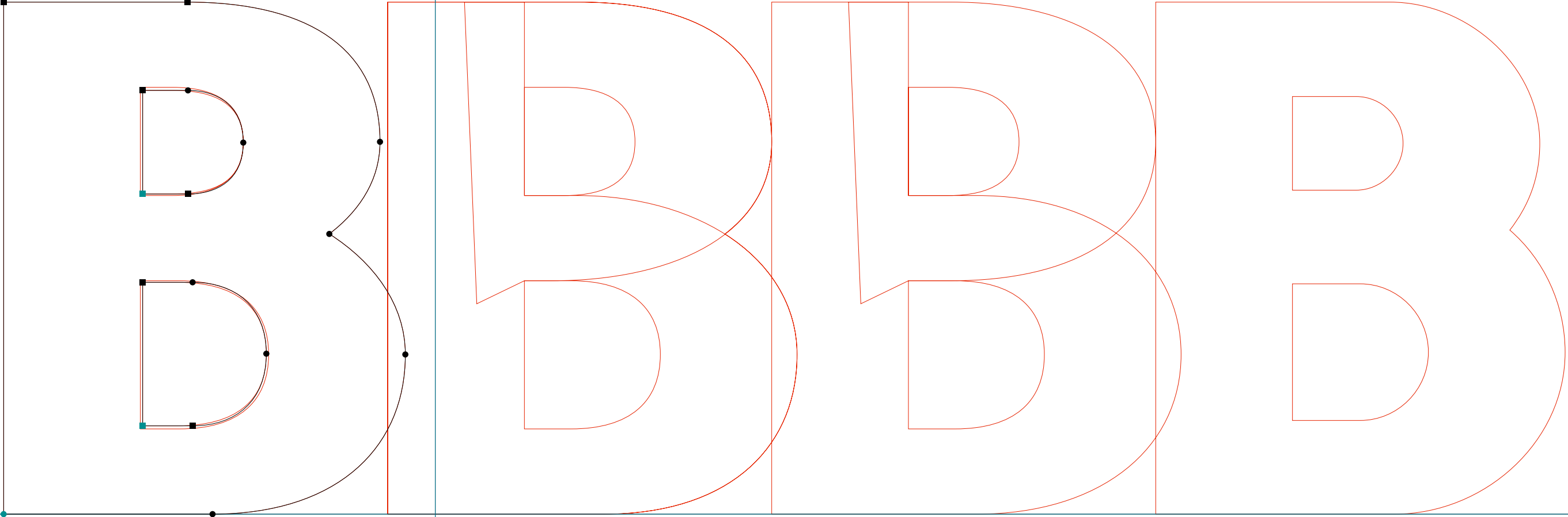

BASE 900

.....
Base900Sans B | C | RoboFog Sketches | 2010 | Emigre Fonts

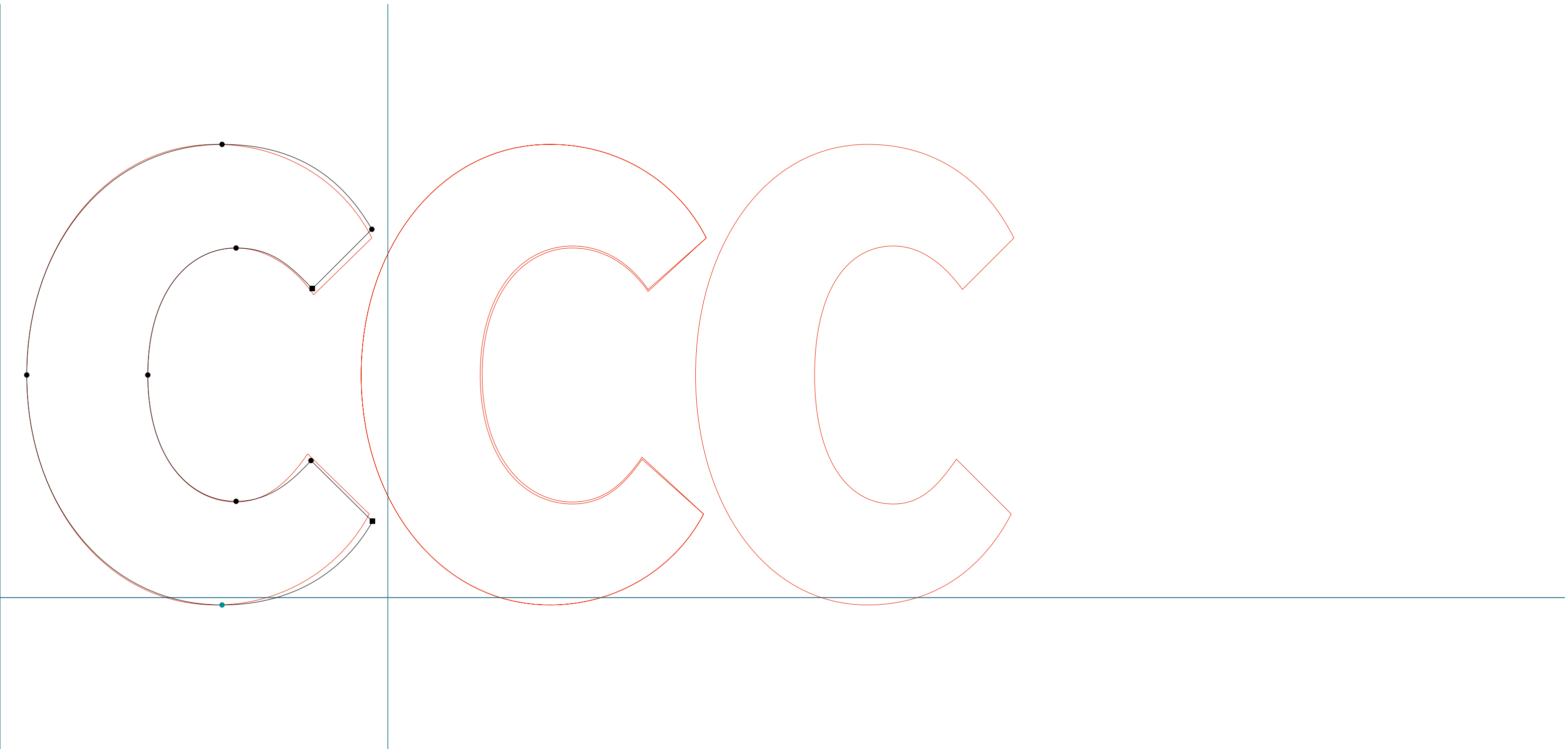

BASE 900

.....
Base900Sans B | G | RoboFog Sketches | 2010 | Emigre Fonts

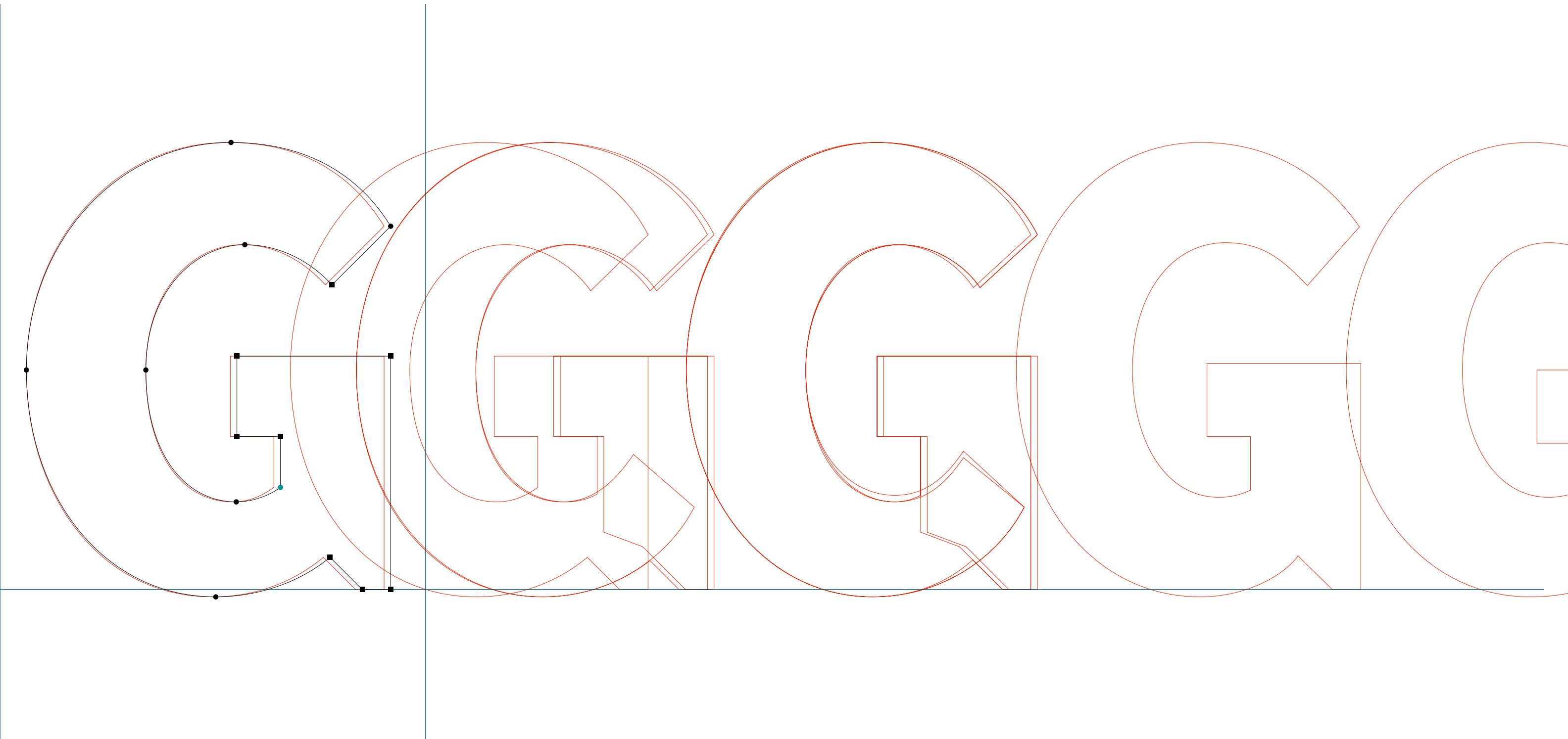

BASE 900

.....
Base900Sans B | J | RoboFog Sketches | 2010 | Emigre Fonts

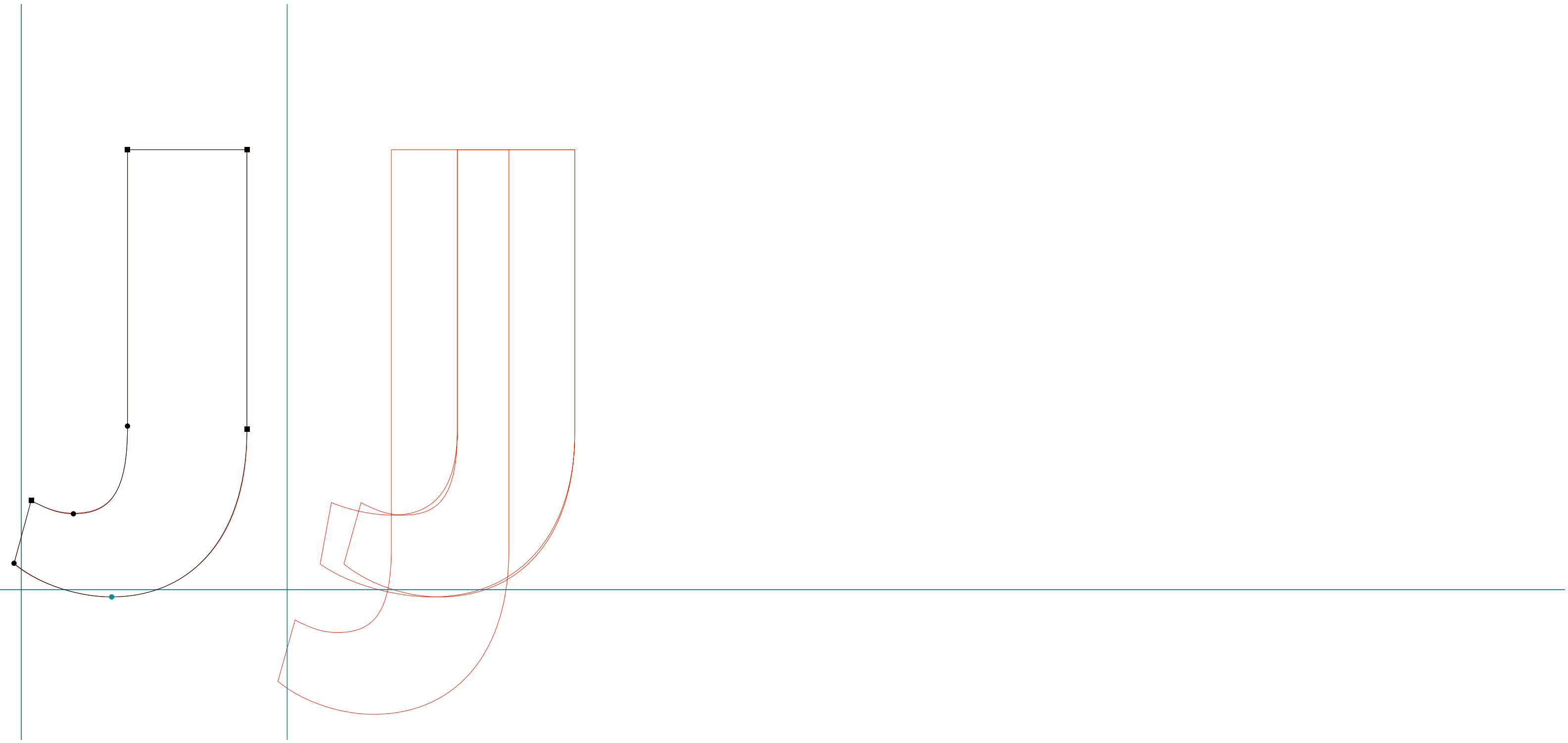

BASE 900

.....
Base900Sans B | K | RoboFog Sketches | 2010 | Emigre Fonts

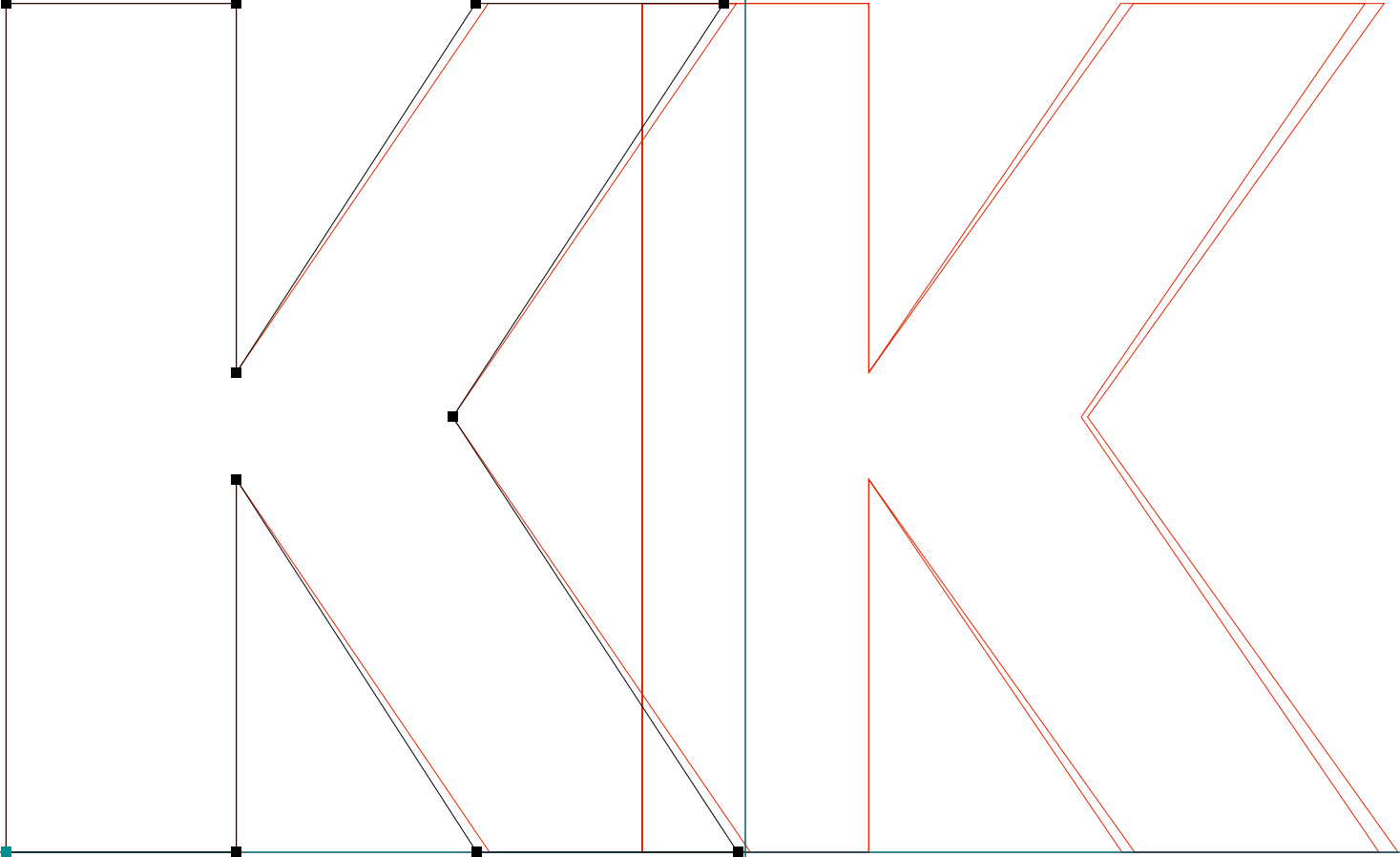

BASE 900

.....
Base900Sans B | 0 | RoboFog Sketches | 2010 | Emigre Fonts

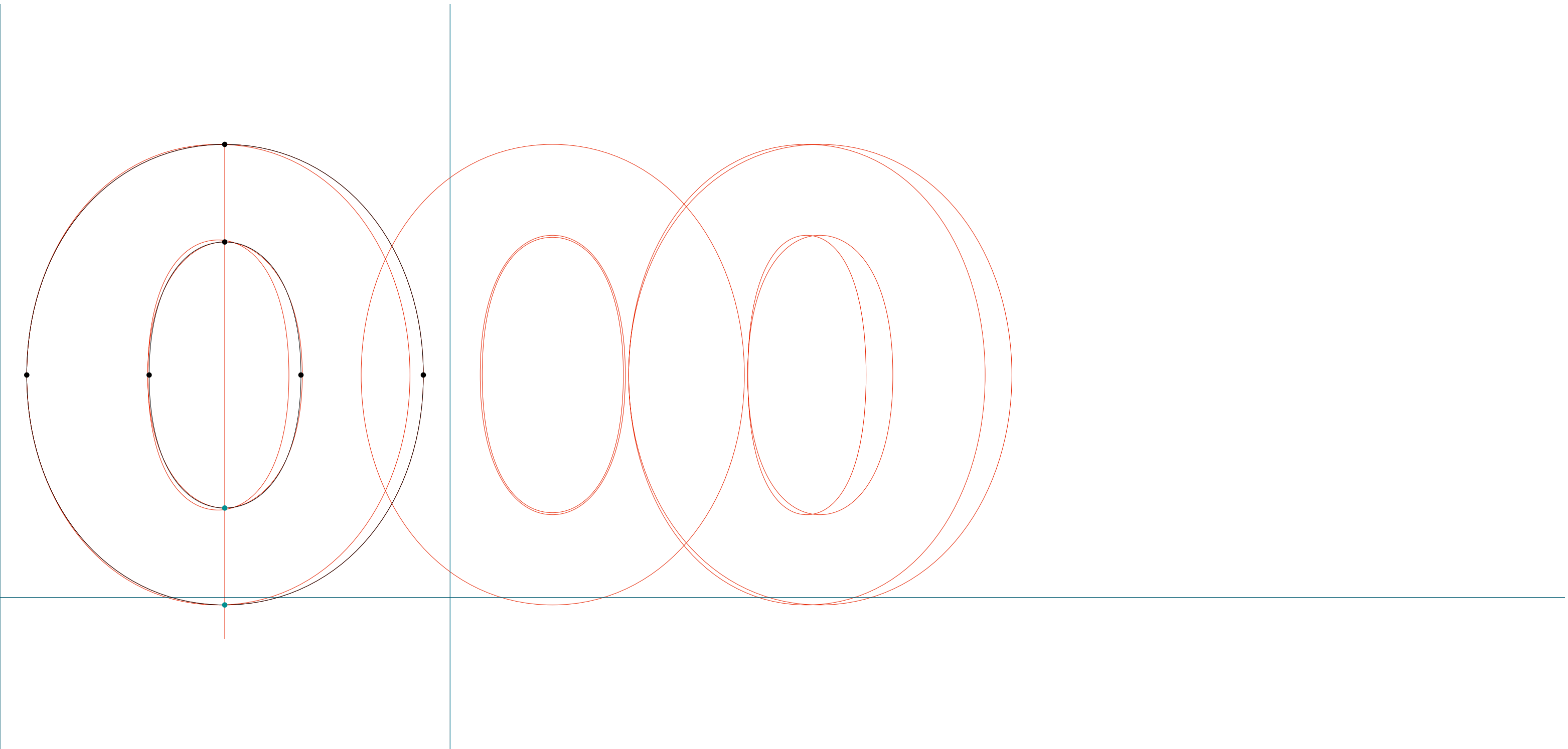

BASE 900

Base900Sans B | Q | RoboFog Sketches | 2010 | Emigre Fonts

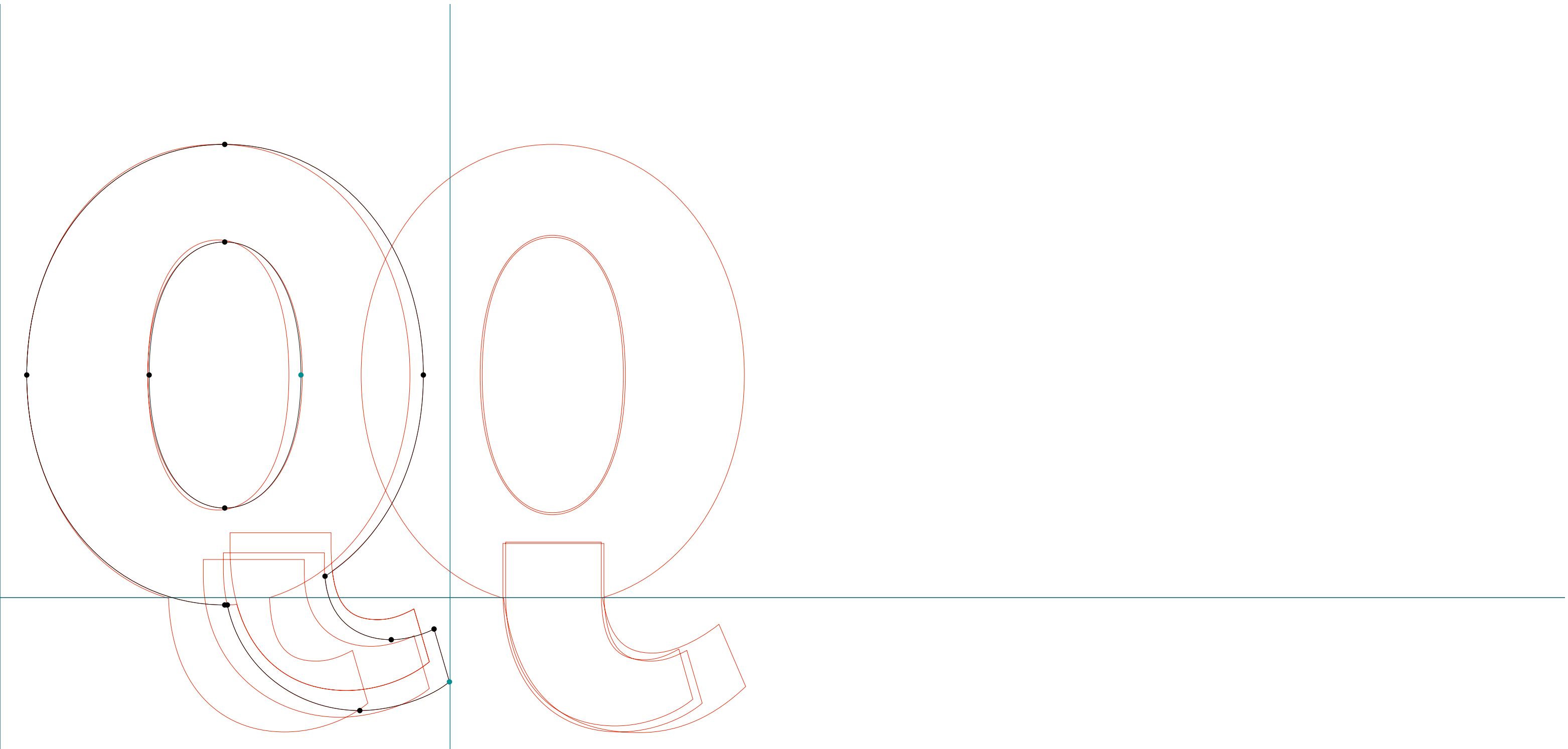

BASE 900

Base900Sans B | W | RoboFog Sketches | 2010 | Emigre Fonts

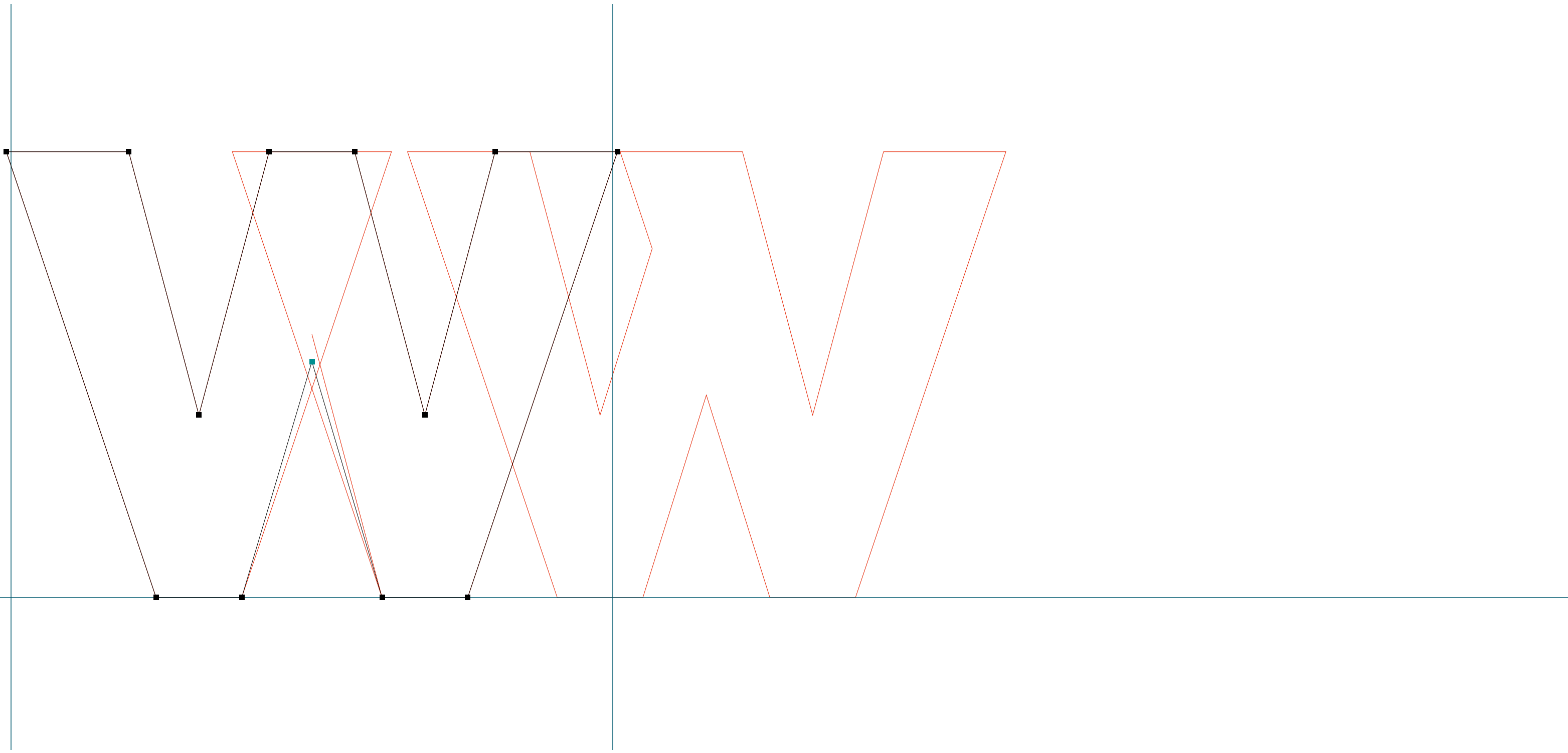

BASE 900

Base900Sans B | e | RoboFog Sketches | 2010 | Emigre Fonts



BASE 900

.....
Base900Sans B | f | RoboFog Sketches | 2010 | Emigre Fonts

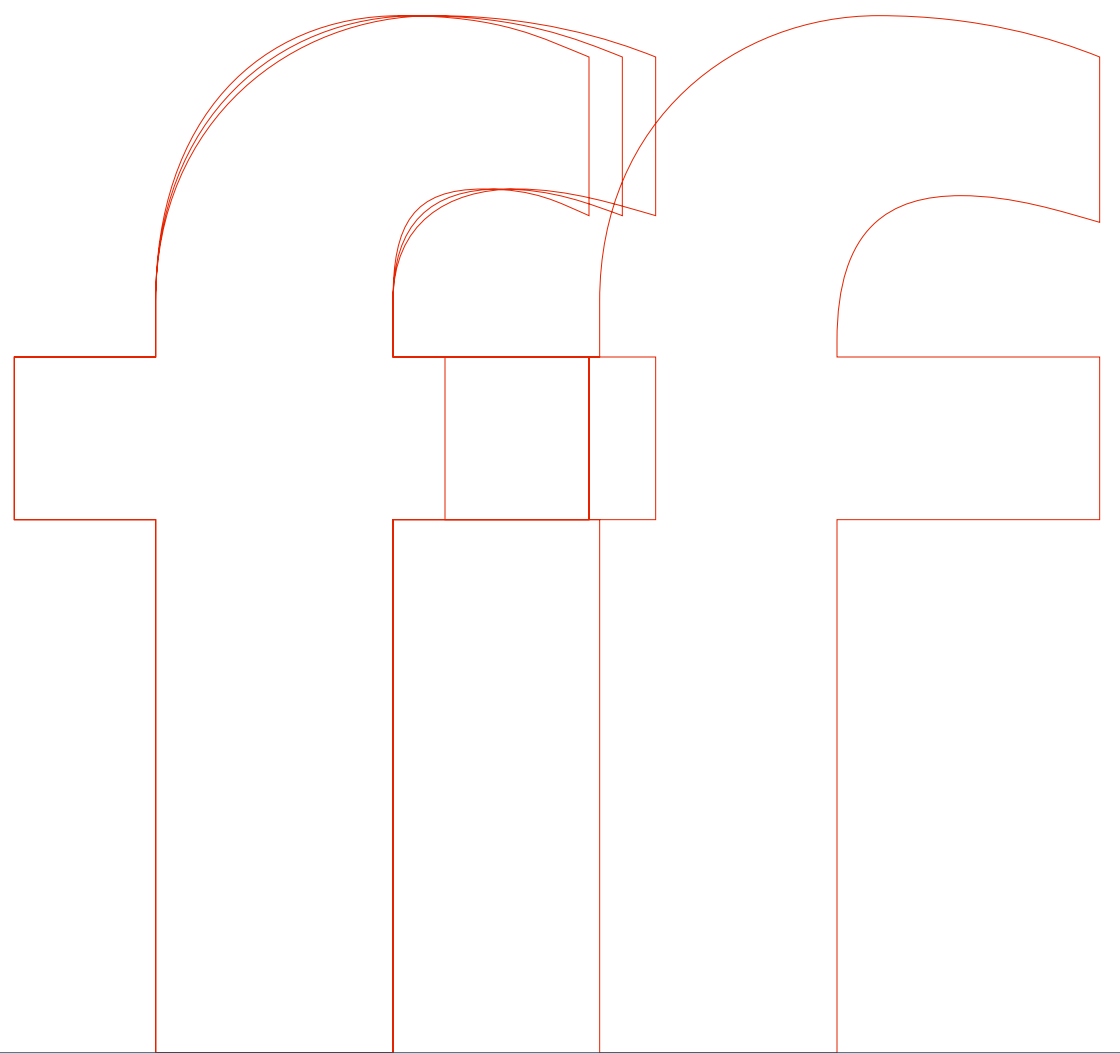
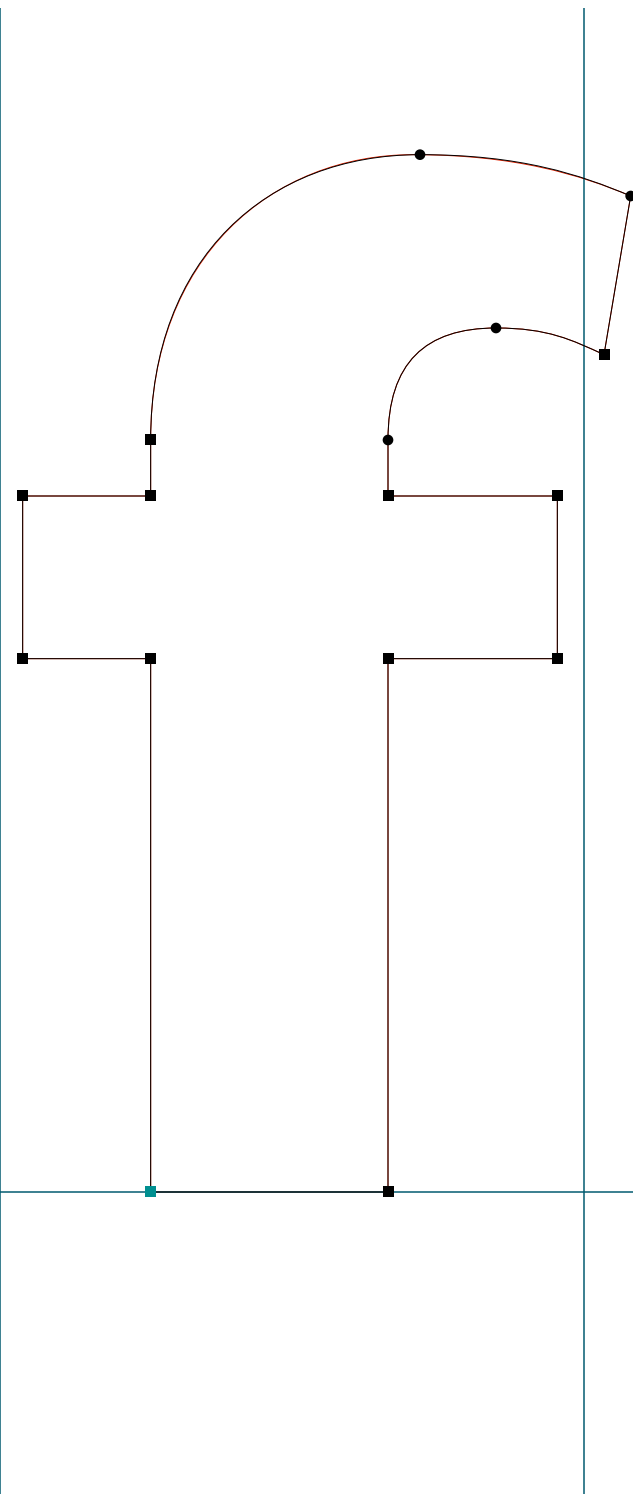

BASE 900

Base900Sans B | h | RoboFog Sketches | 2010 | Emigre Fonts

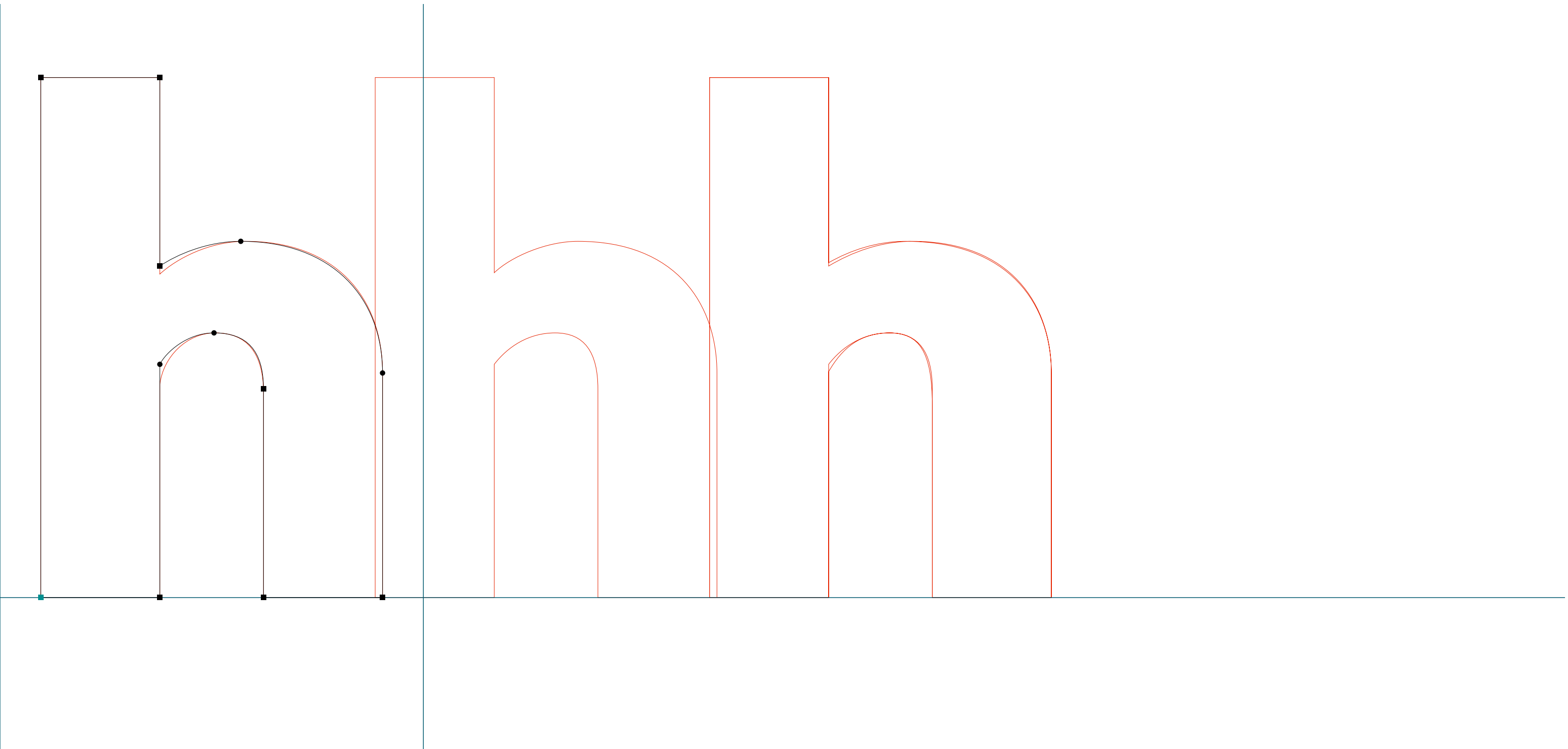

BASE 900

.....
Base900Sans B | m | RoboFog Sketches | 2010 | Emigre Fonts

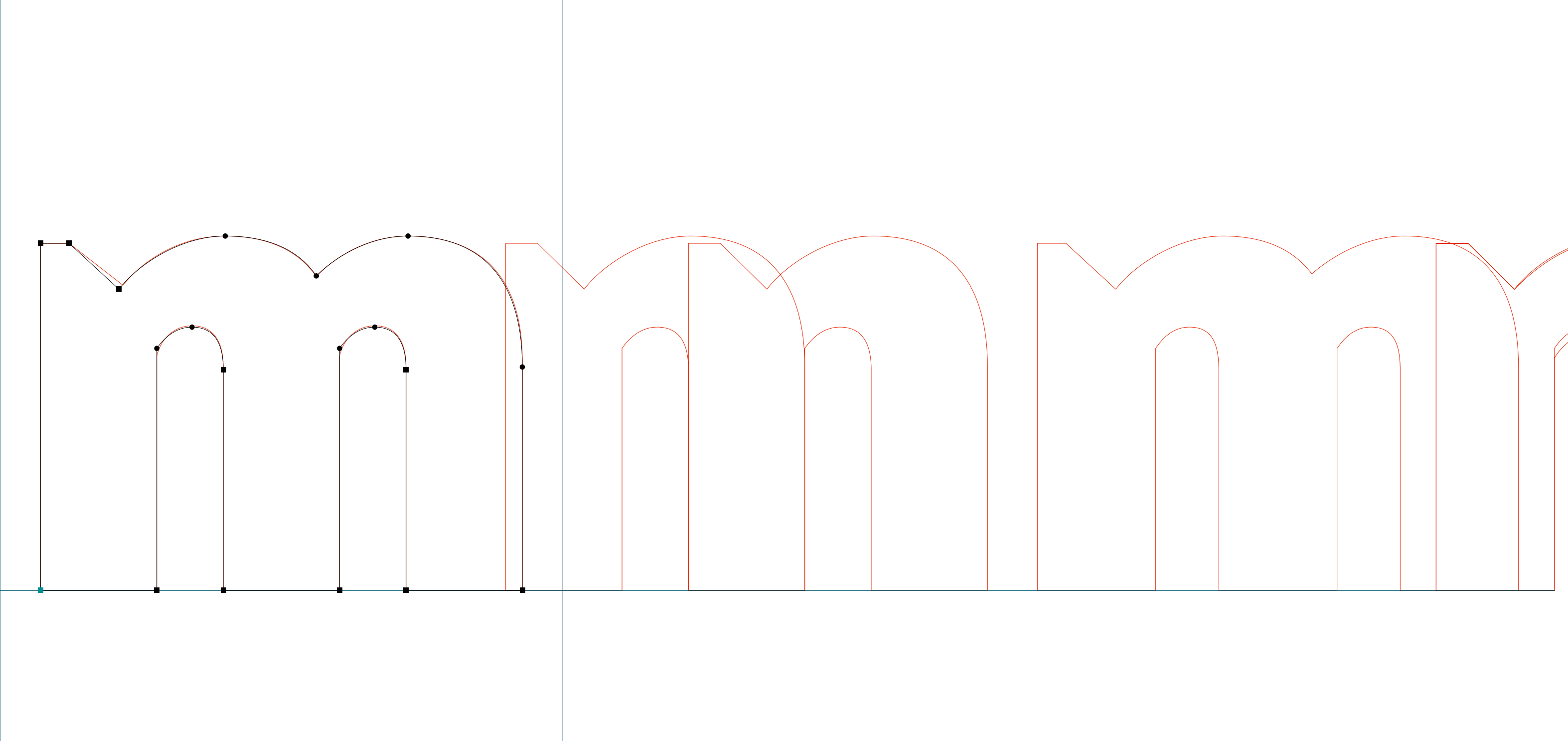

BASE 900

Base900Sans B | n | RoboFog Sketches | 2010 | Emigre Fonts

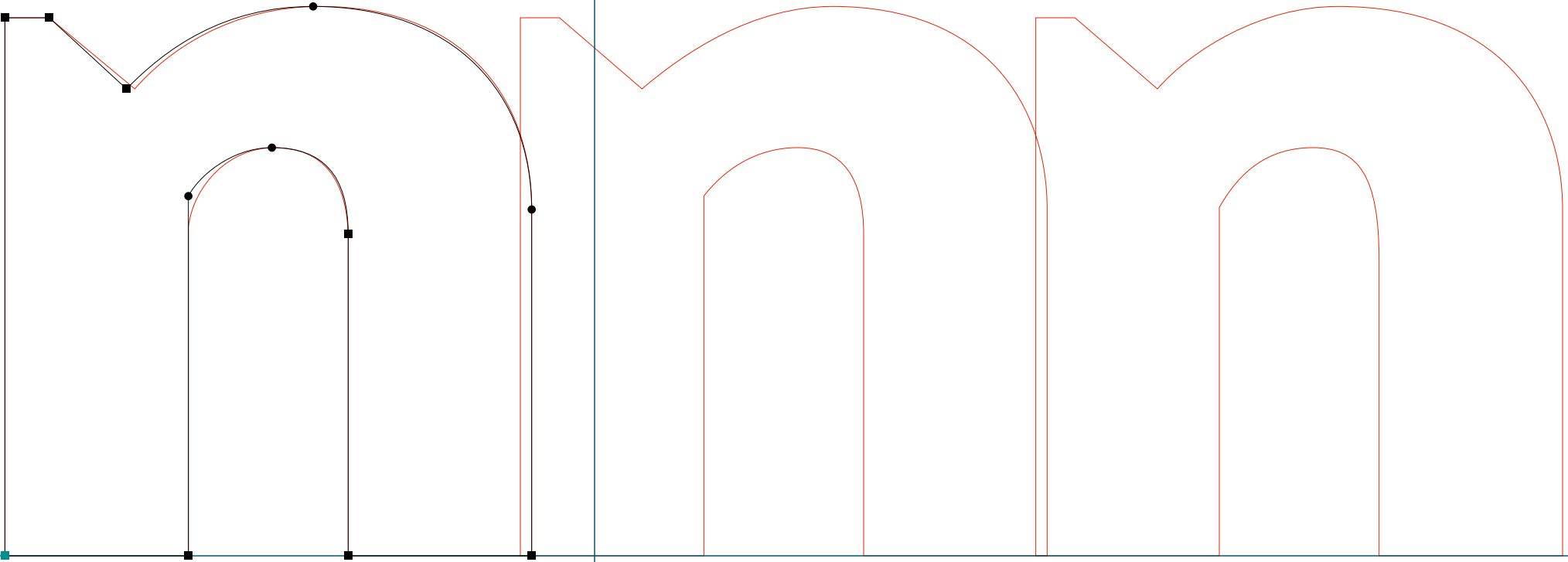

BASE 900

.....
Base900Sans B | r | RoboFog Sketches | 2010 | Emigre Fonts

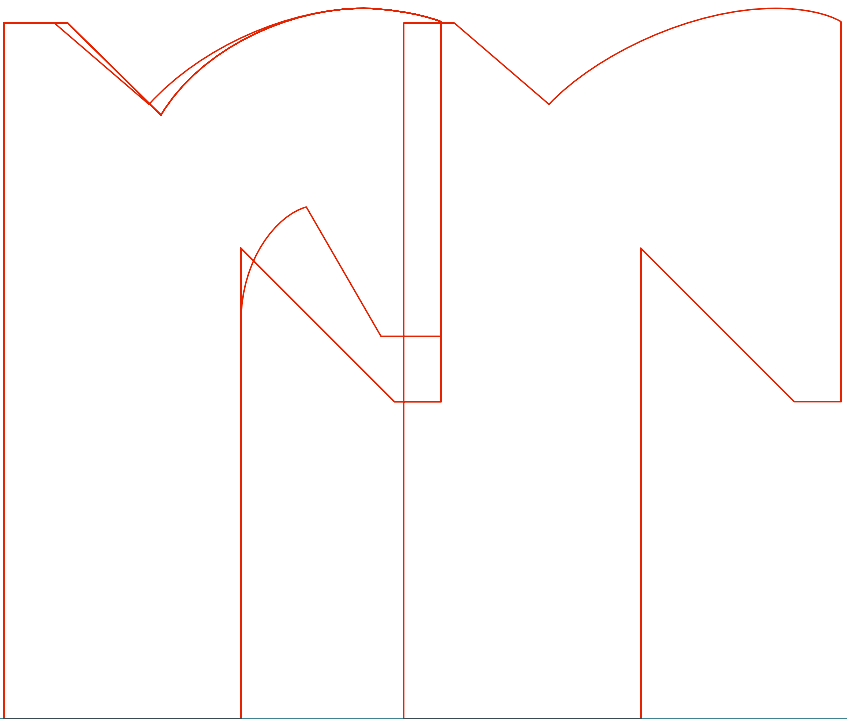
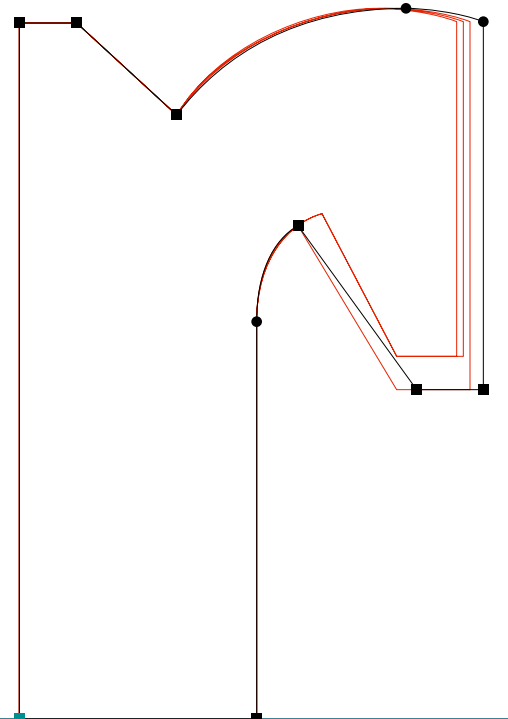

BASE 900

.....
Base900Sans B | s | RoboFog Sketches | 2010 | Emigre Fonts

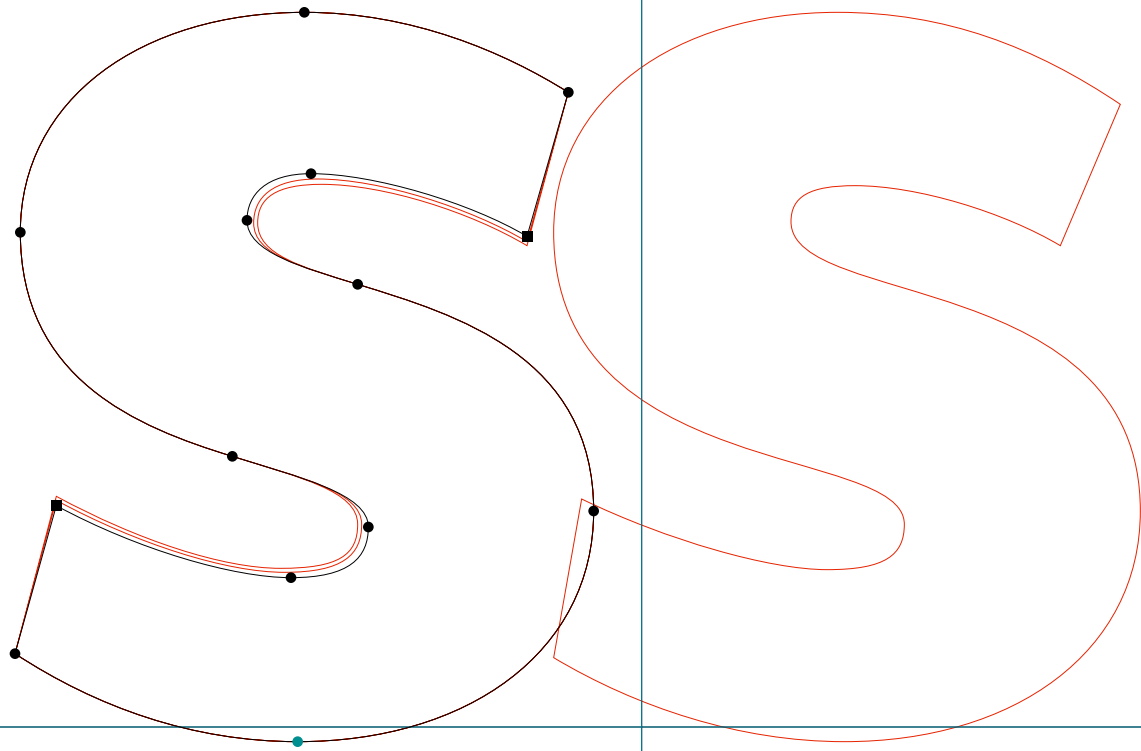

BASE 900

Base900Sans B | t | RoboFog Sketches | 2010 | Emigre Fonts

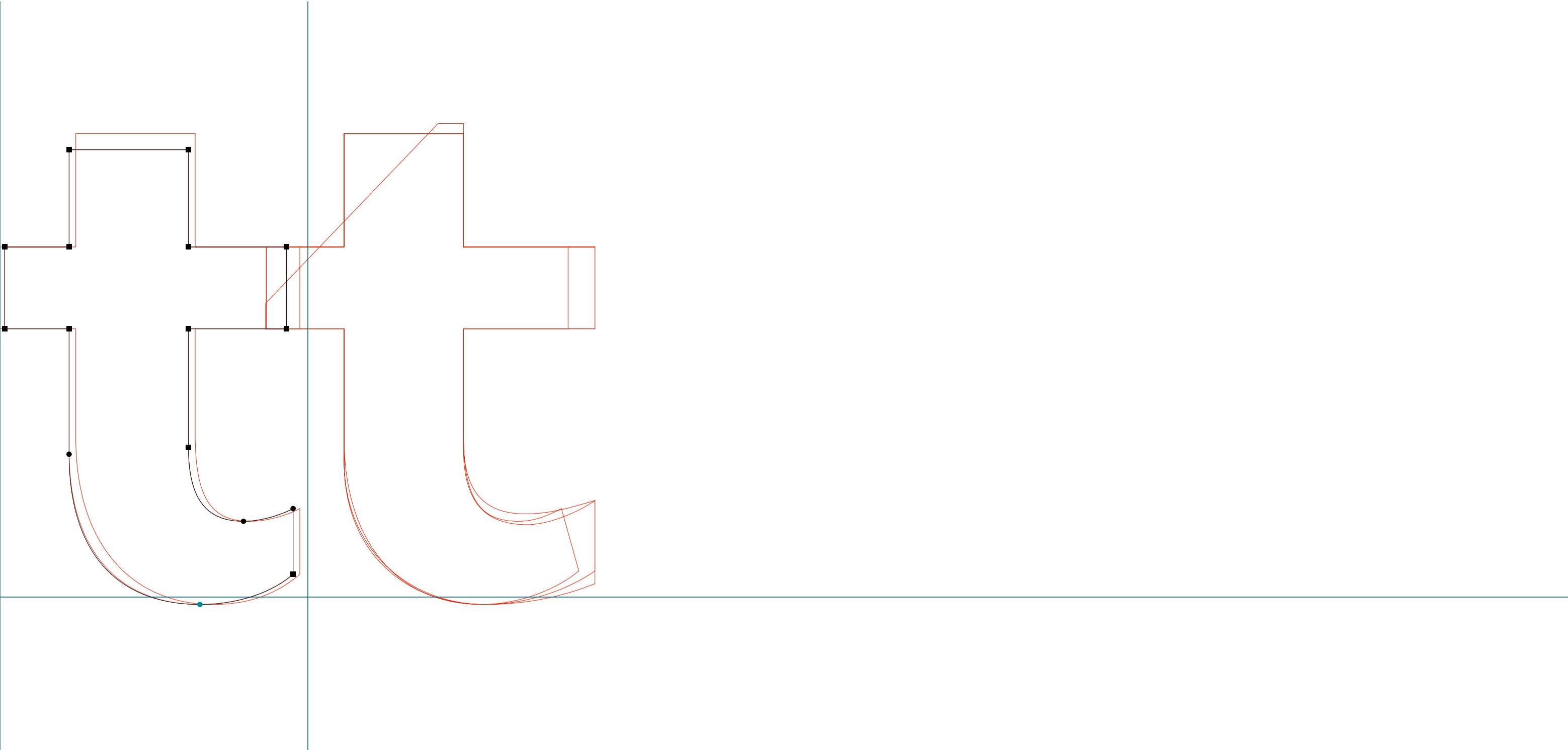

BASE 900

Base900Sans B | u | RoboFog Sketches | 2010 | Emigre Fonts

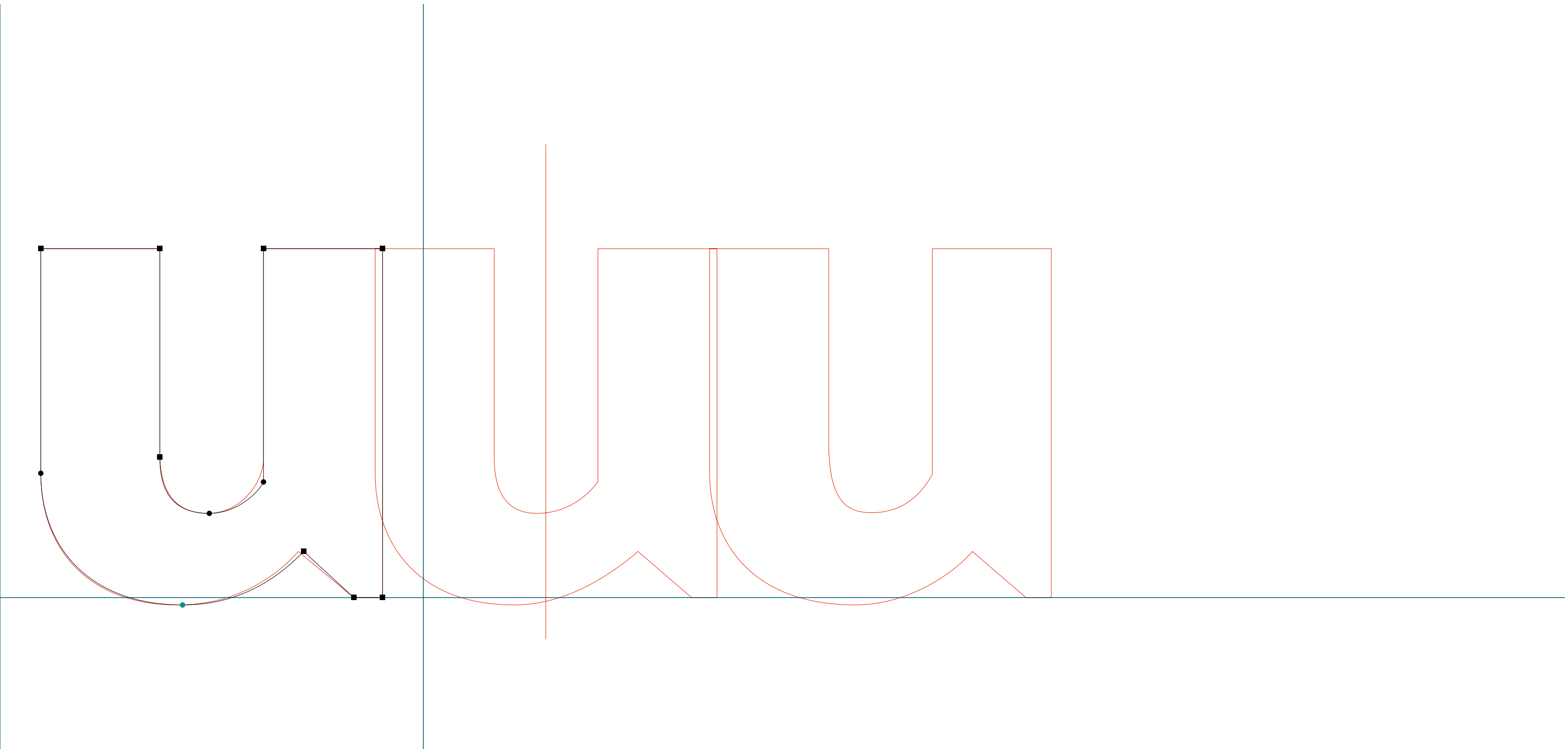

BASE 900

.....
Base900Sans B | w | RoboFog Sketches | 2010 | Emigre Fonts

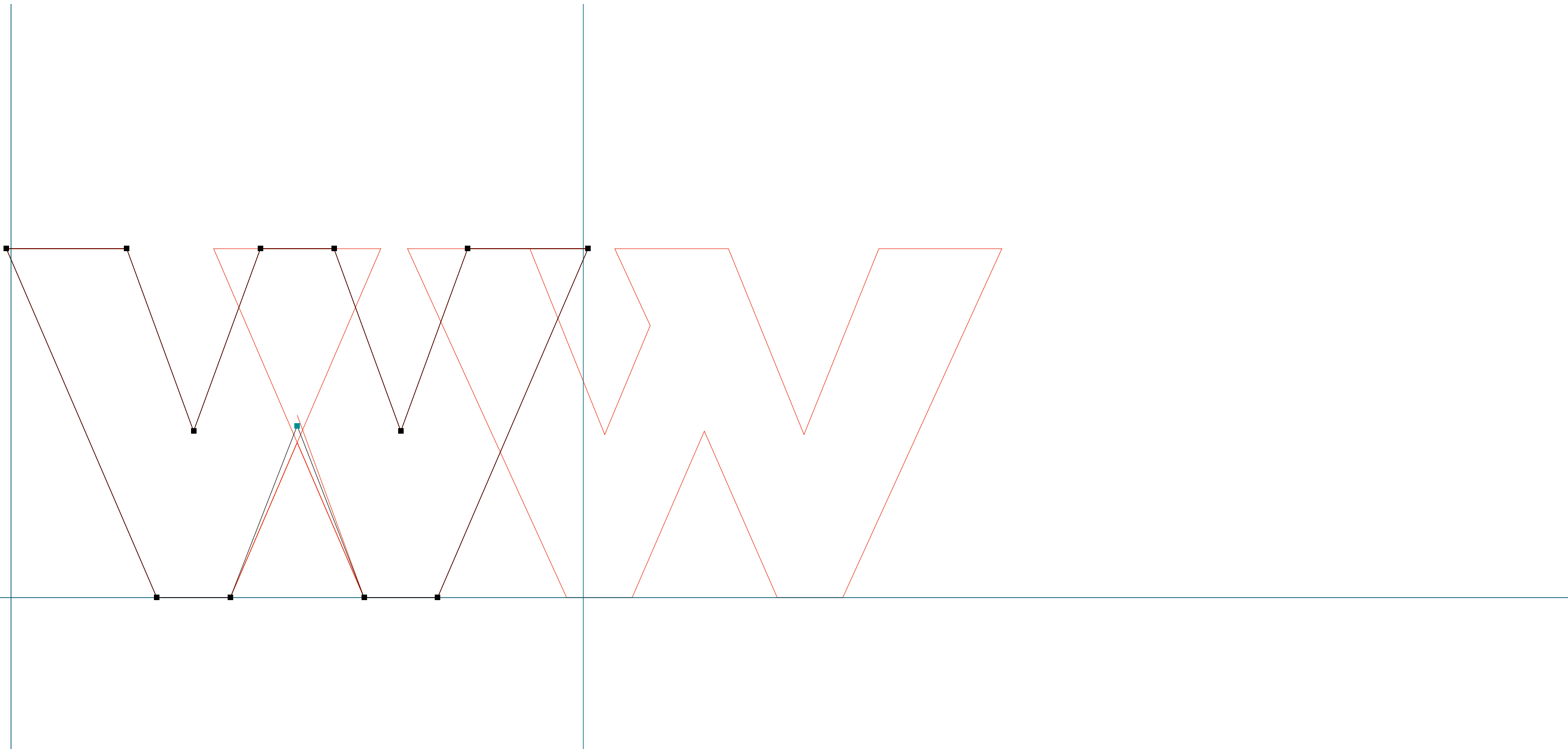

BASE 900

.....
Base900Sans B | y | RoboFog Sketches | 2010 | Emigre Fonts



BASE 900

Base900Sans B | cent | RoboFog Sketches | 2010 | Emigre Fonts

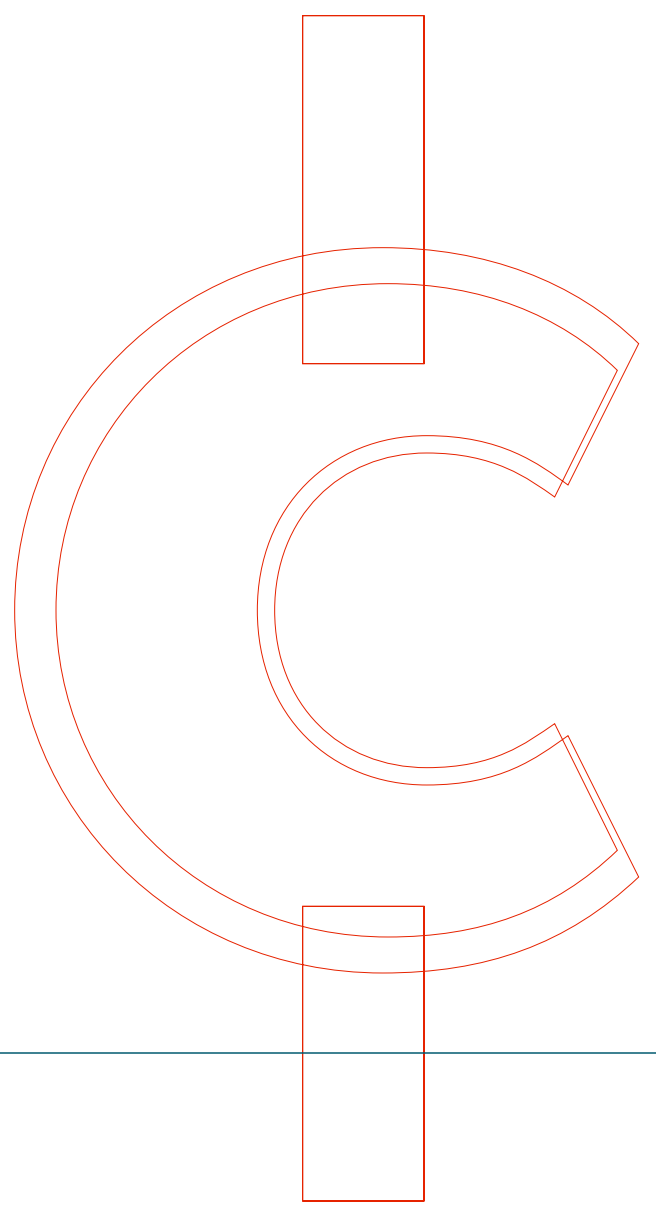
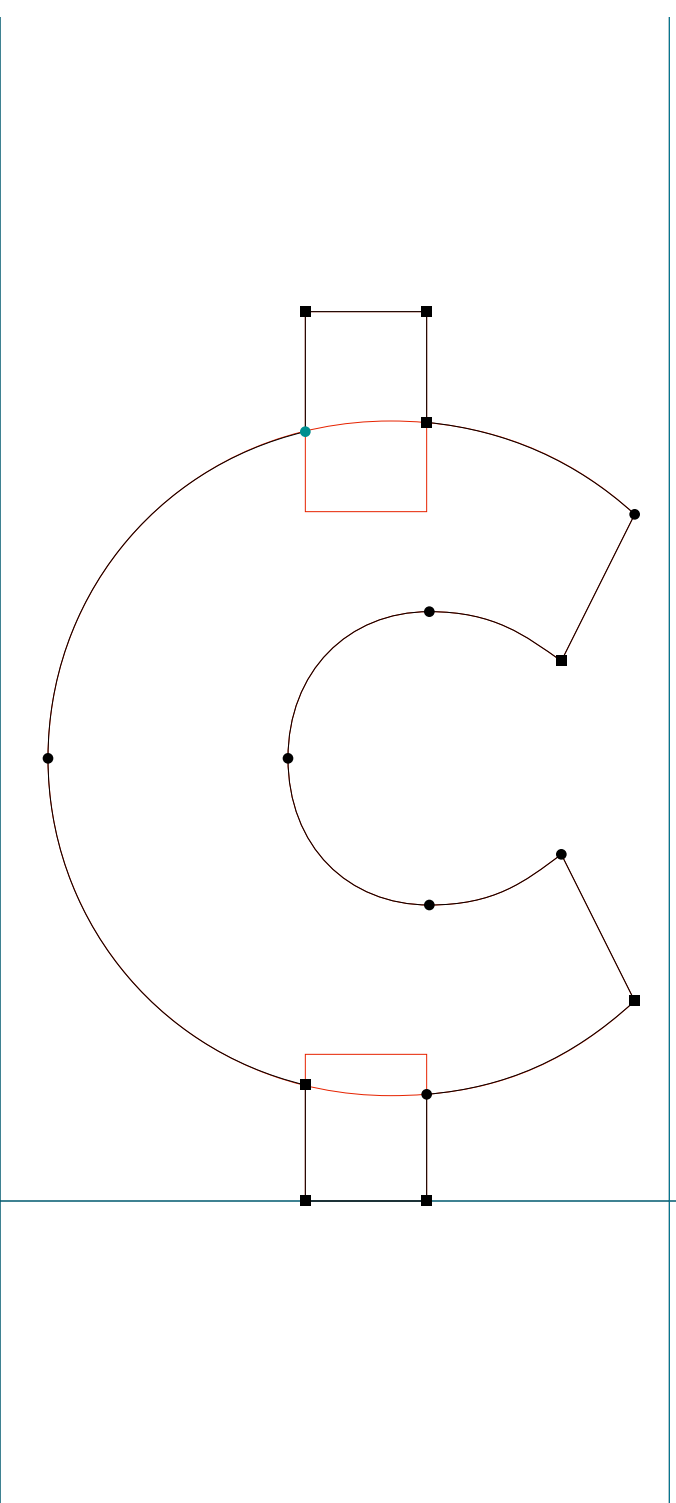

BASE 900

Base900Sans B | section | RoboFog Sketches | 2010 | Emigre Fonts

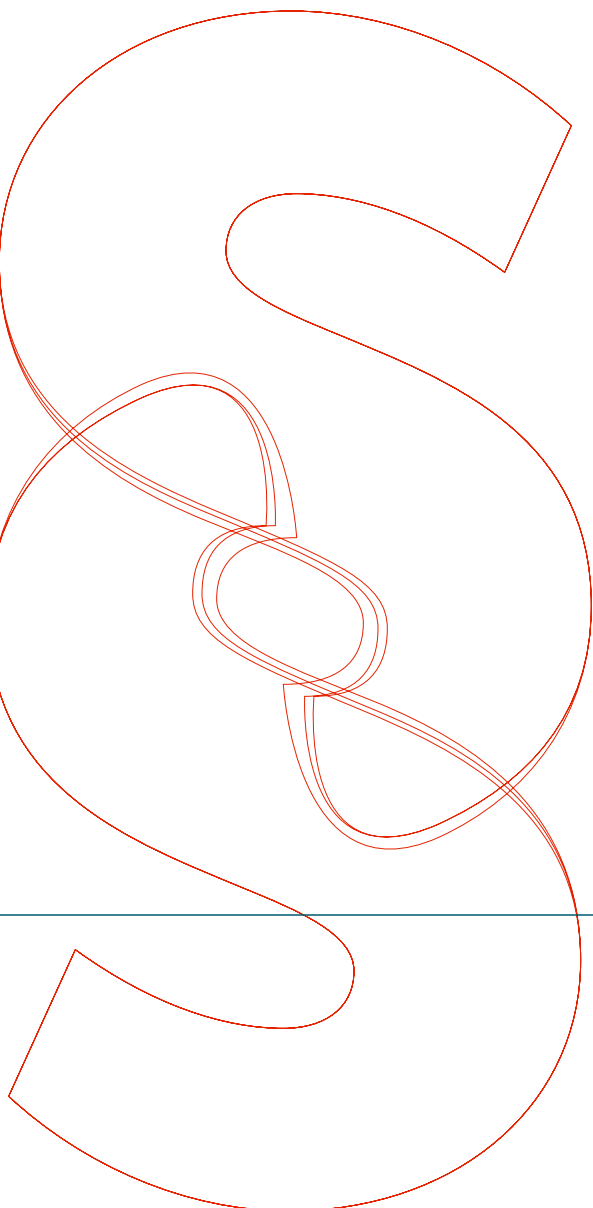
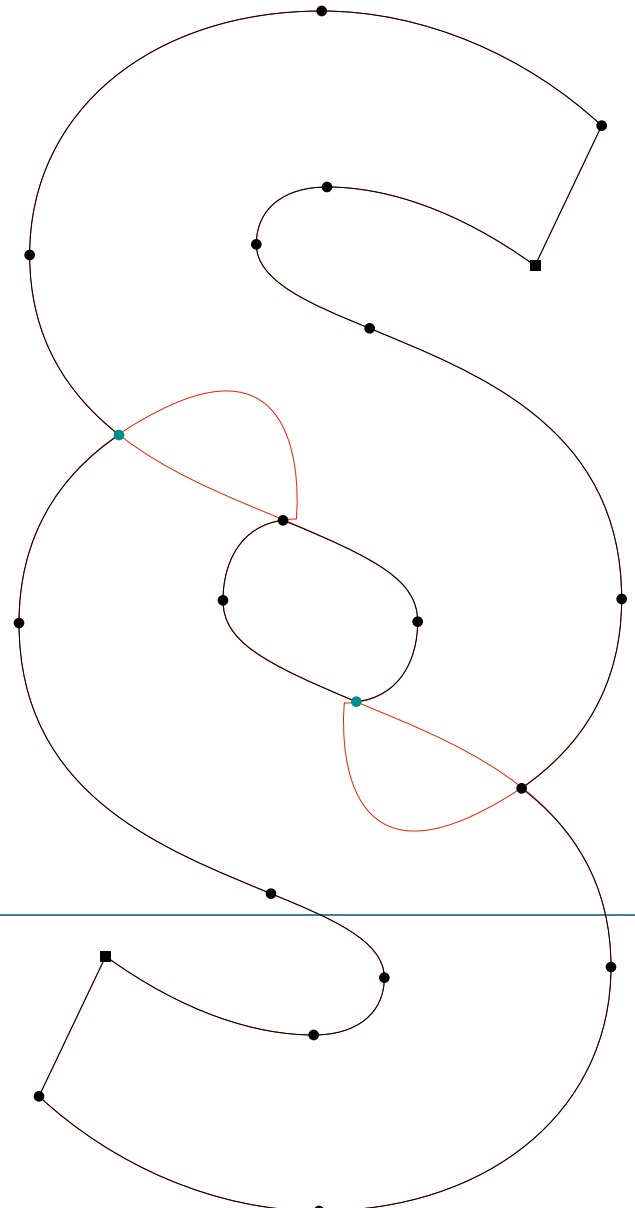
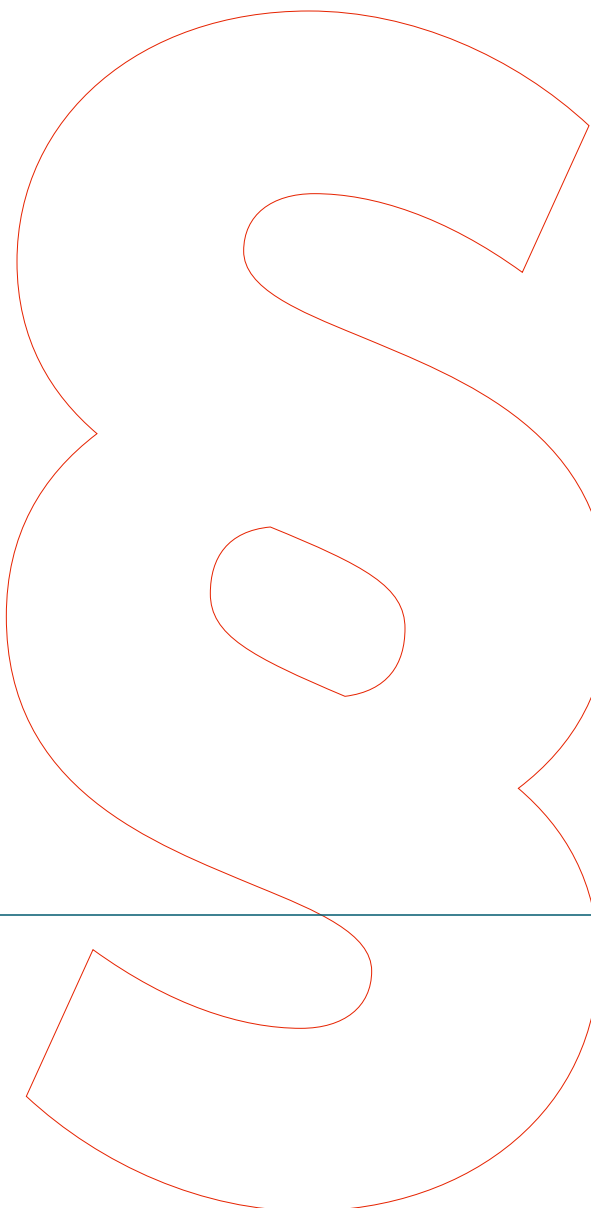

BASE 900

.....
Base900Sans B | lessequal | RoboFog Sketches | 2010 | Emigre Fonts

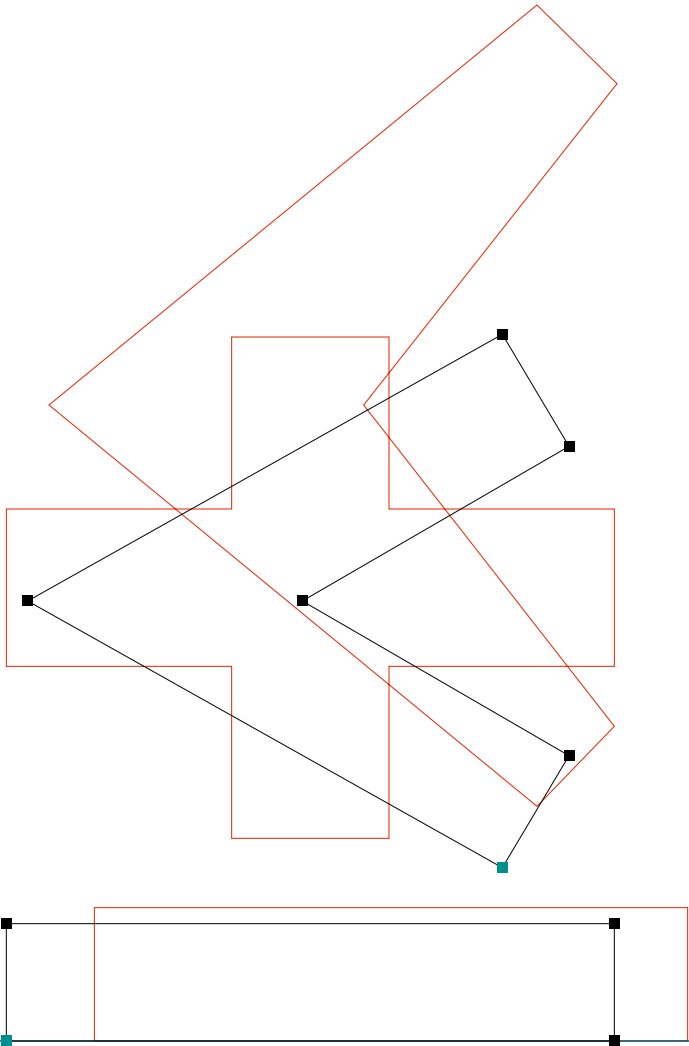

BASE 900

Base900Sans B | quoteright | RoboFog Sketches | 2010 | Emigre Fonts

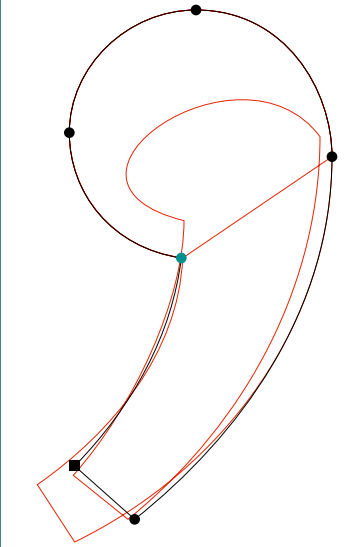

BASE 900

Base900Sans B | currency | RoboFog Sketches | 2010 | Emigre Fonts

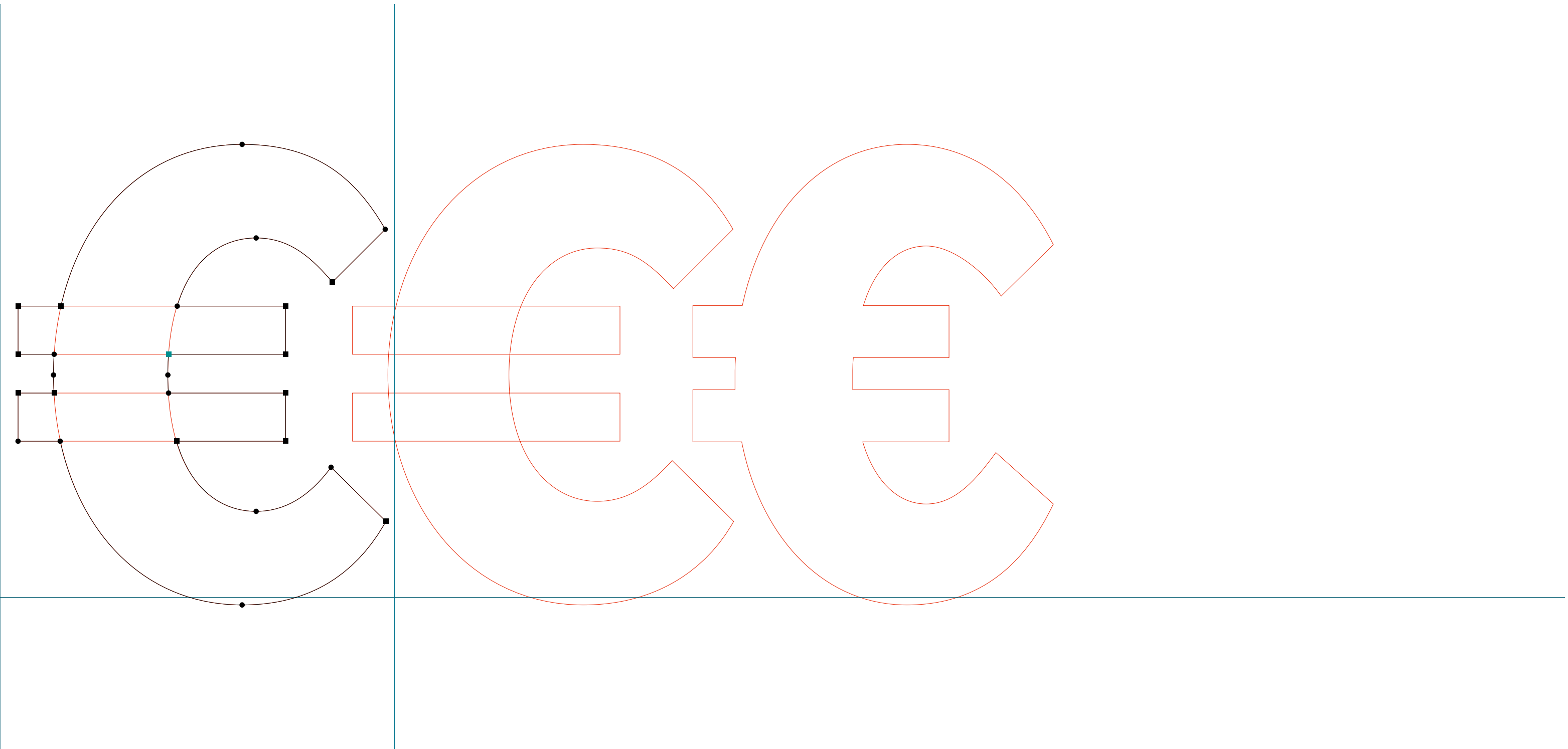

BASE 900

Base900Sans B | fi | RoboFog Sketches | 2010 | Emigre Fonts

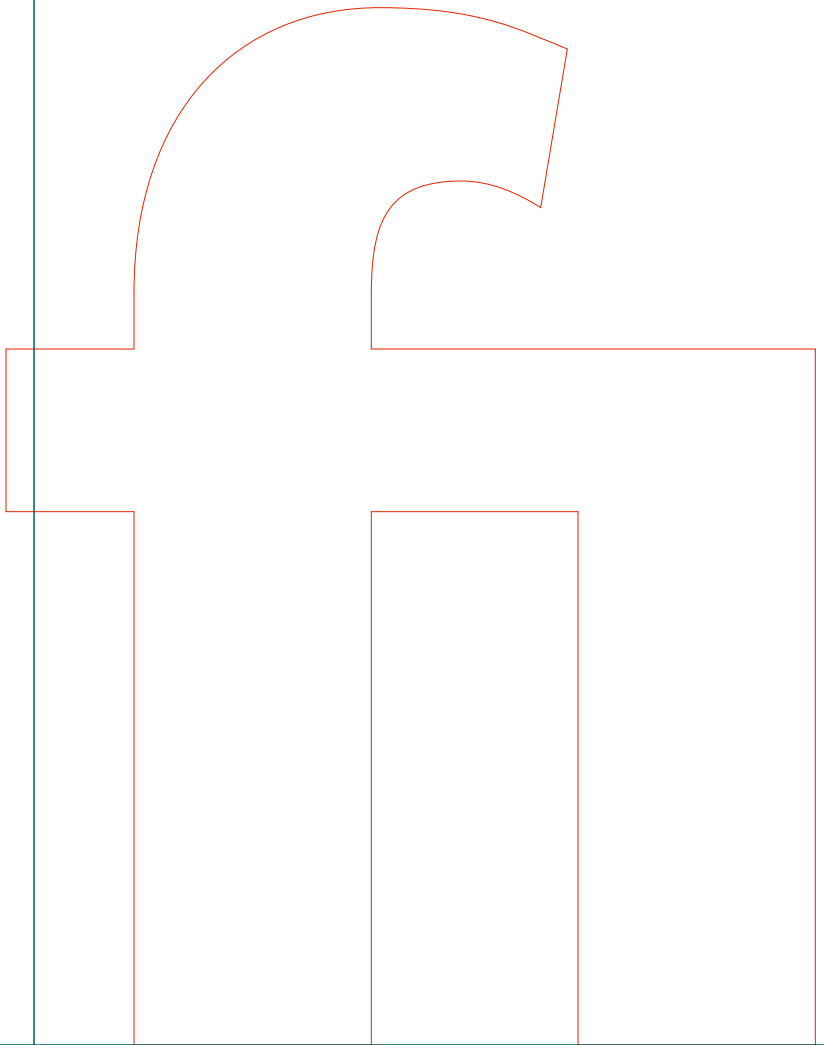
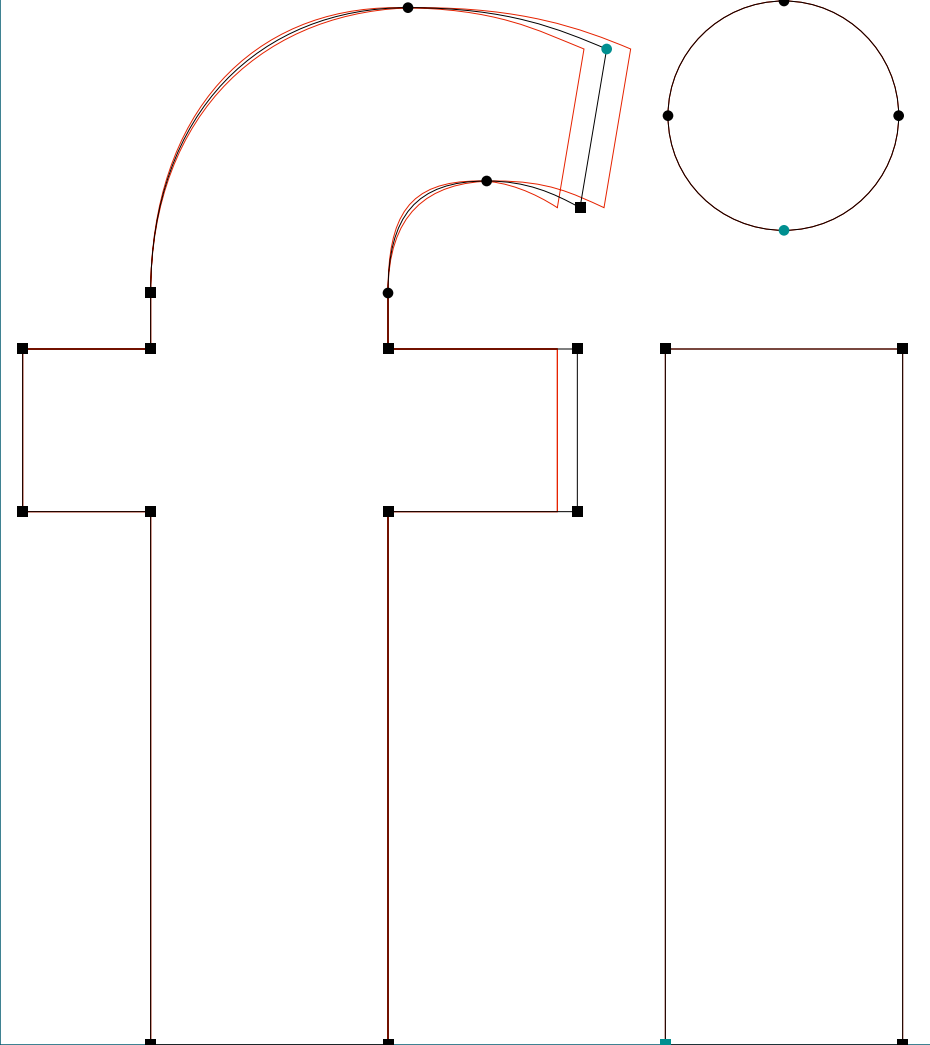
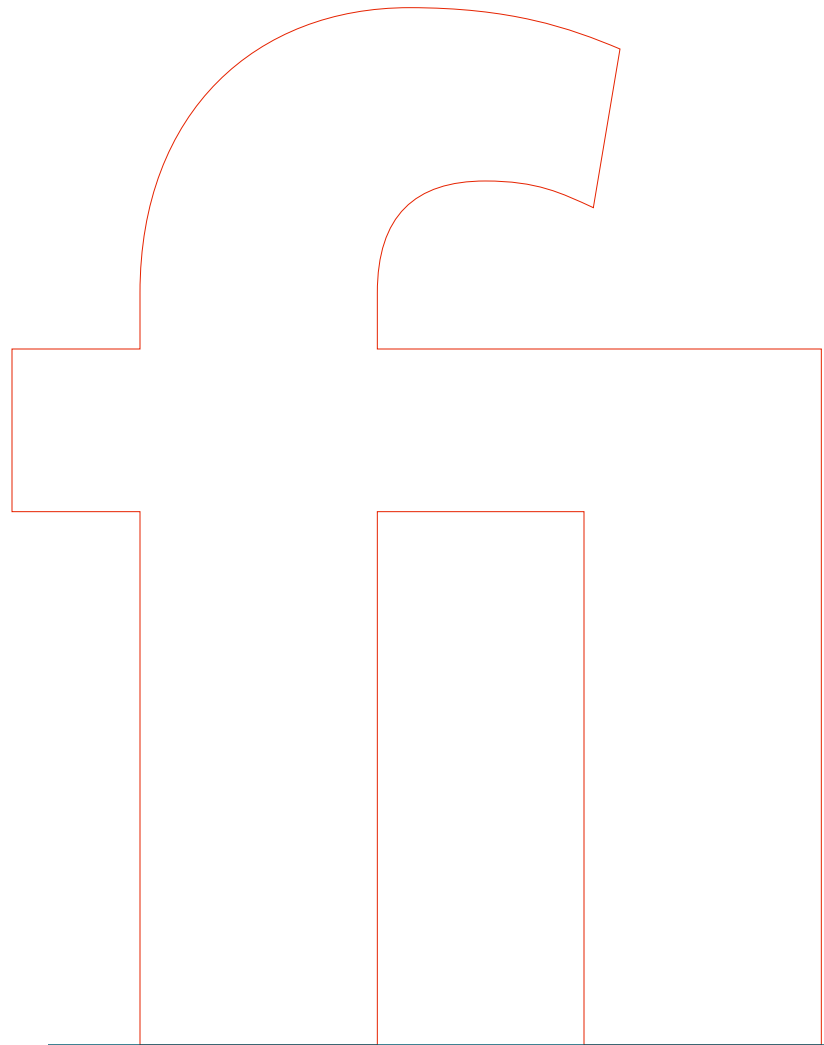

BASE 900

.....
Base900Sans B | circumflex | RoboFog Sketches | 2010 | Emigre Fonts

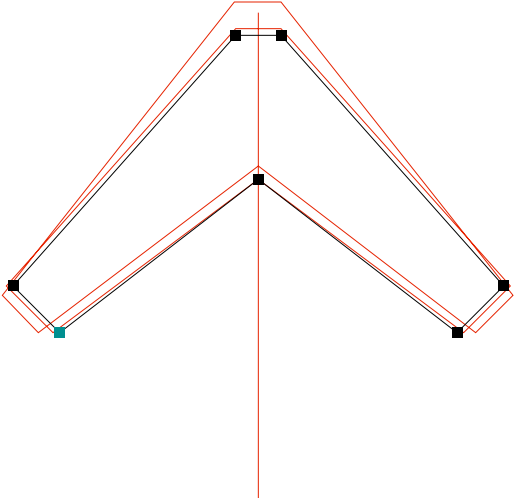

BASE 900

Base900Sans B | tilde | RoboFog Sketches | 2010 | Emigre Fonts

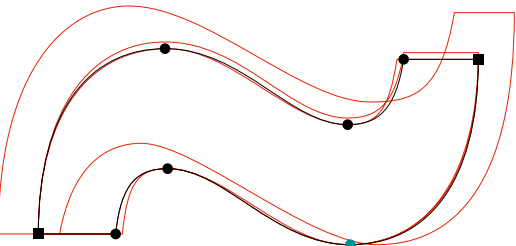

BASE 900

Base900Sans H | eth | RoboFog Sketches | 2010 | Emigre Fonts

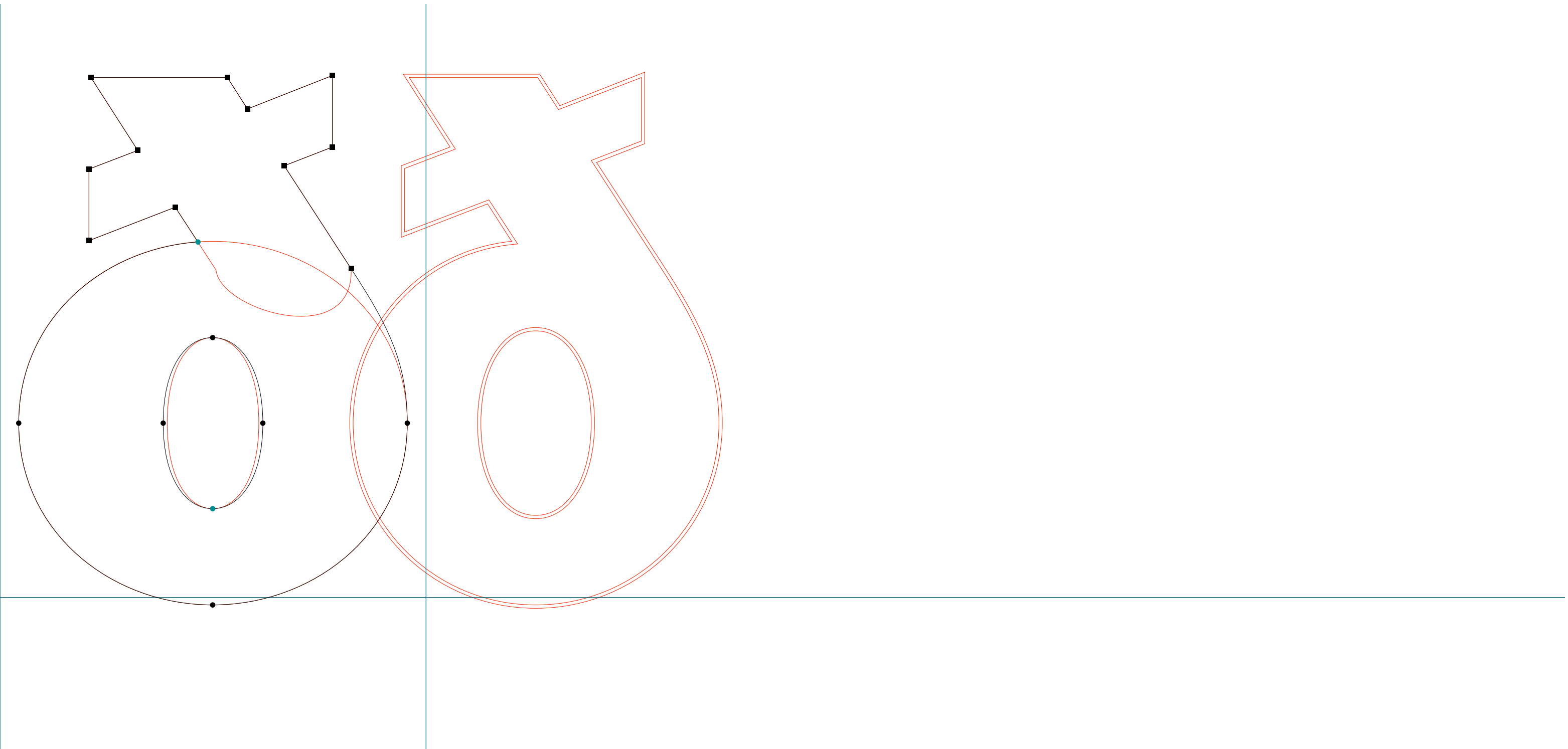

BASE 900

.....
Base900Sans H | DC3 | RoboFog Sketches | 2010 | Emigre Fonts

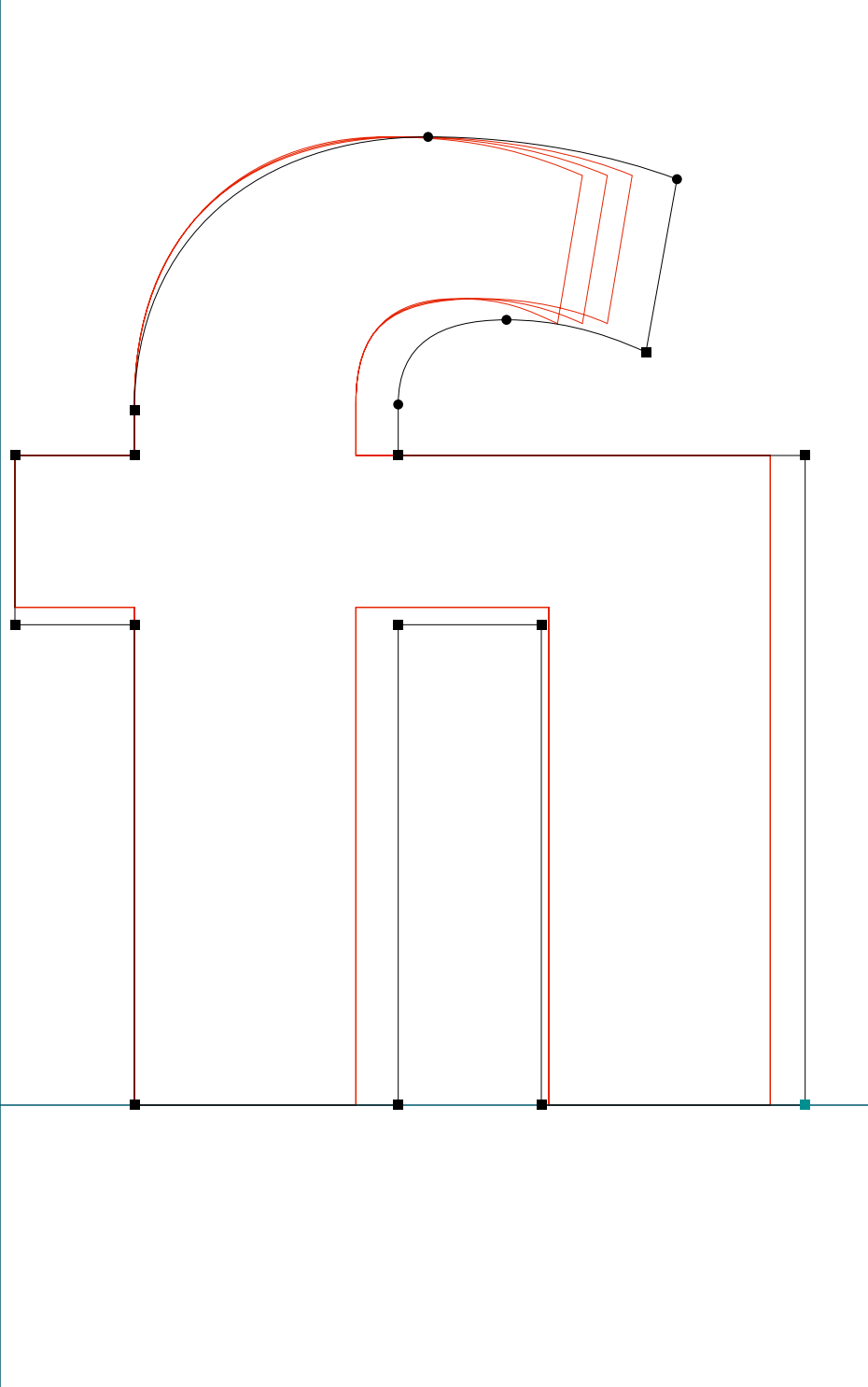

BASE 900

Base900Sans H | DC4 | RoboFog Sketches | 2010 | Emigre Fonts

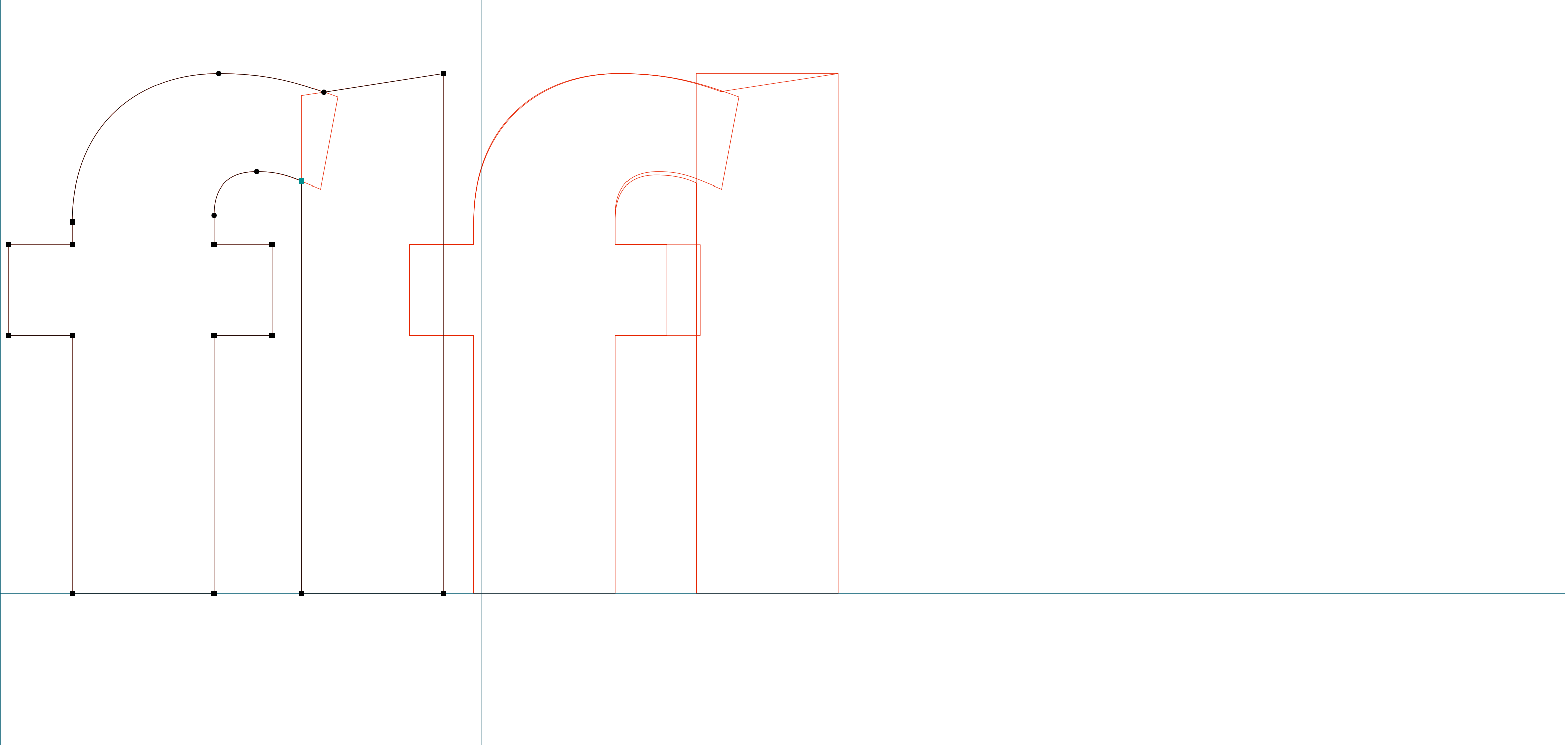

BASE 900

Base900Sans H | dollar | RoboFog Sketches | 2010 | Emigre Fonts



BASE 900

.....
Base900Sans H | five | RoboFog Sketches | 2010 | Emigre Fonts

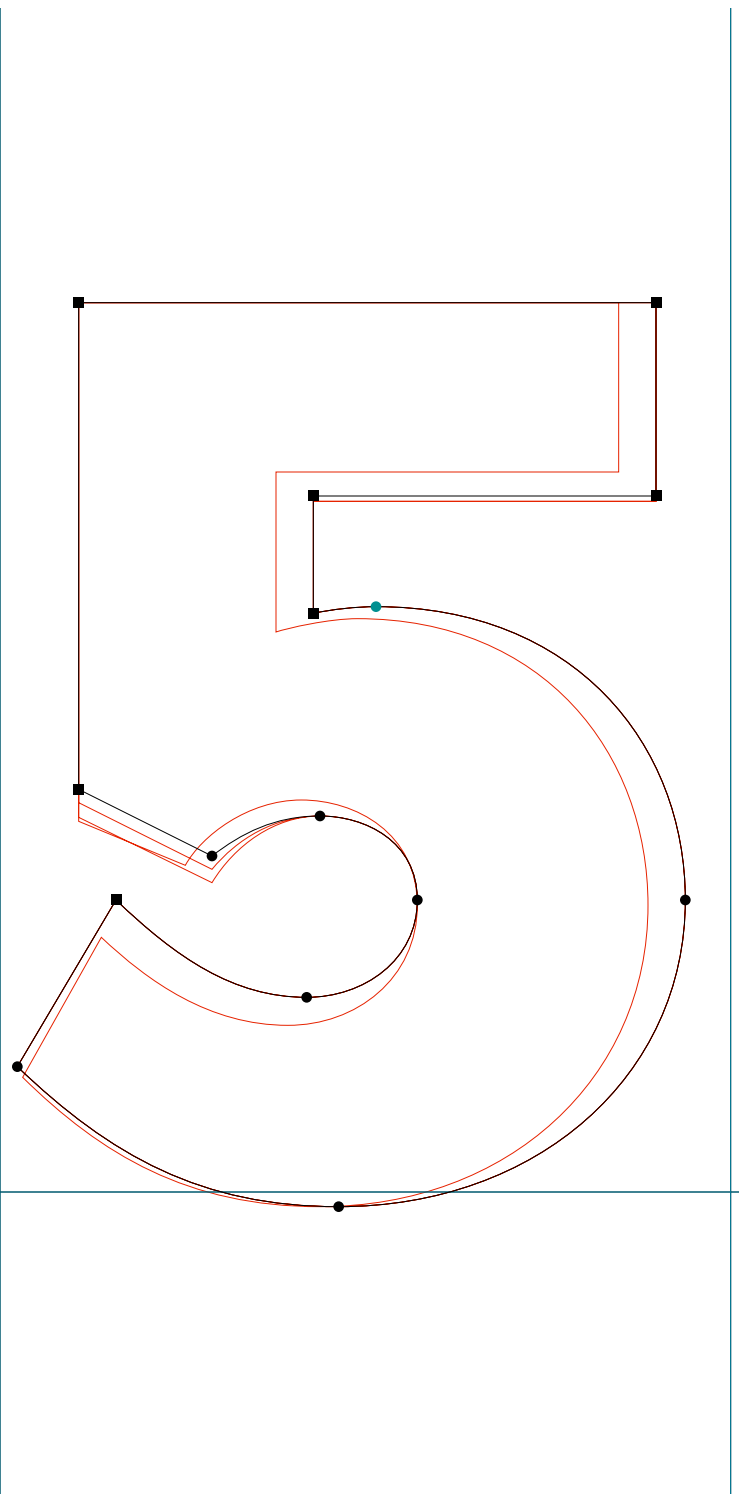

BASE 900

.....
Base900Sans H | eight | RoboFog Sketches | 2010 | Emigre Fonts

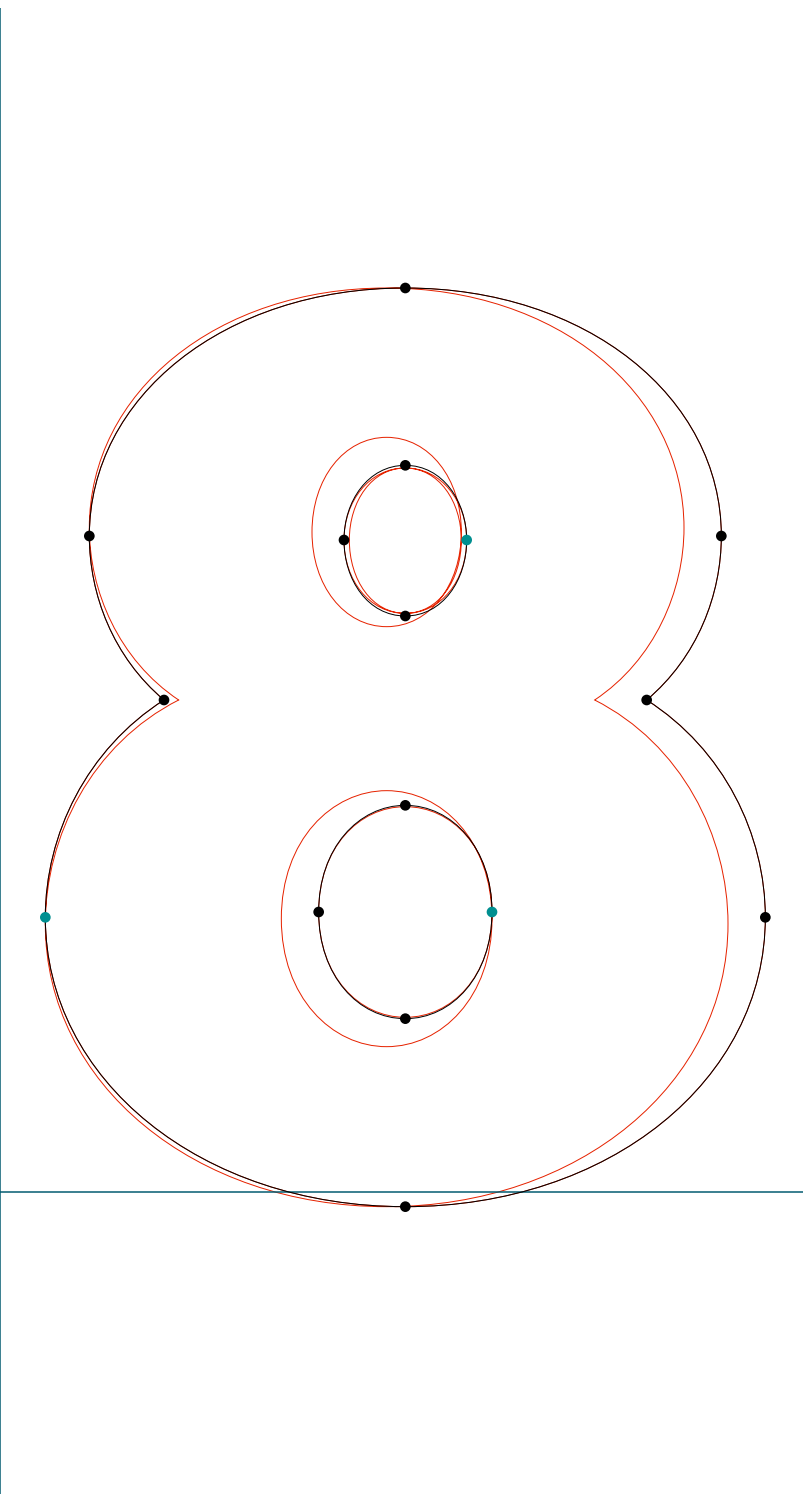

BASE 900

.....
Base900Sans H | C | RoboFog Sketches | 2010 | Emigre Fonts

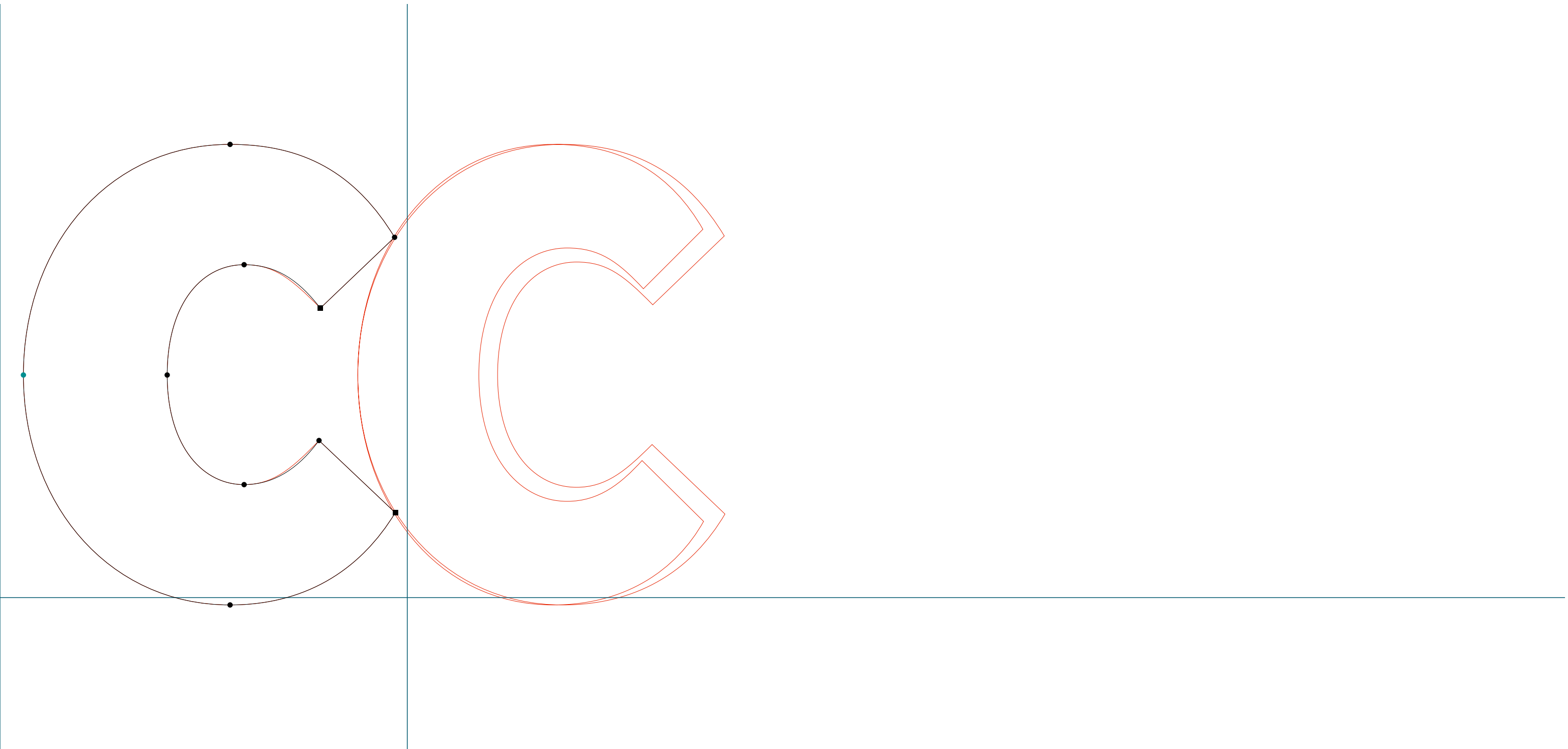

BASE 900

.....
Base900Sans H | M | RoboFog Sketches | 2010 | Emigre Fonts

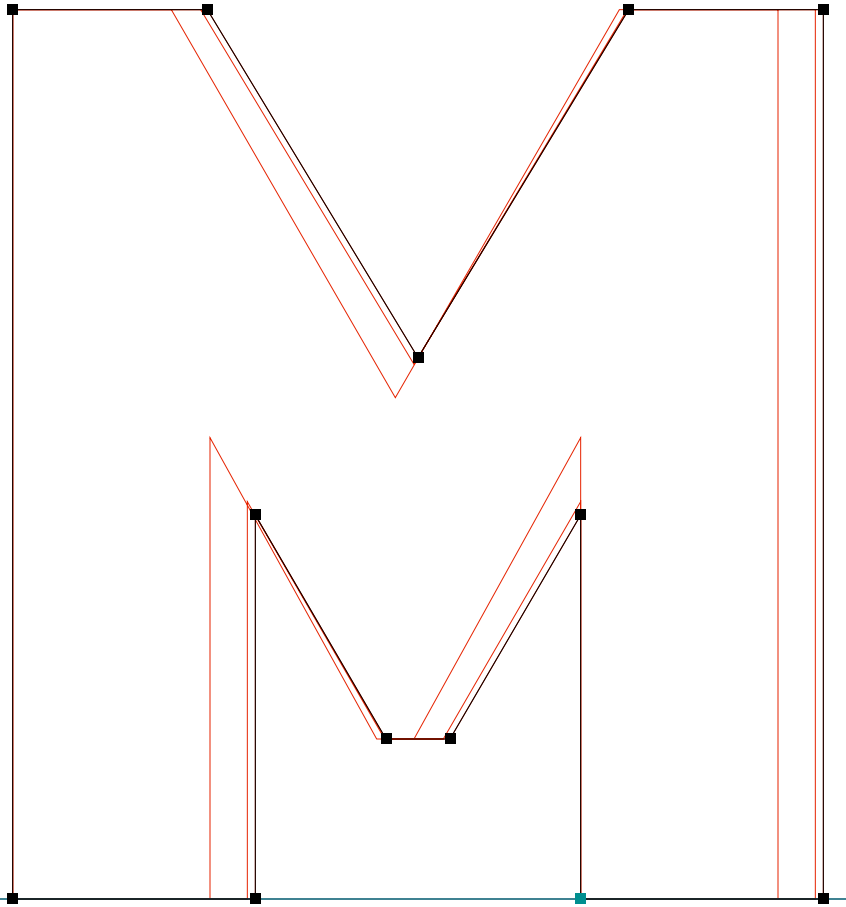

BASE 900

.....
Base900Sans H | Q | RoboFog Sketches | 2010 | Emigre Fonts

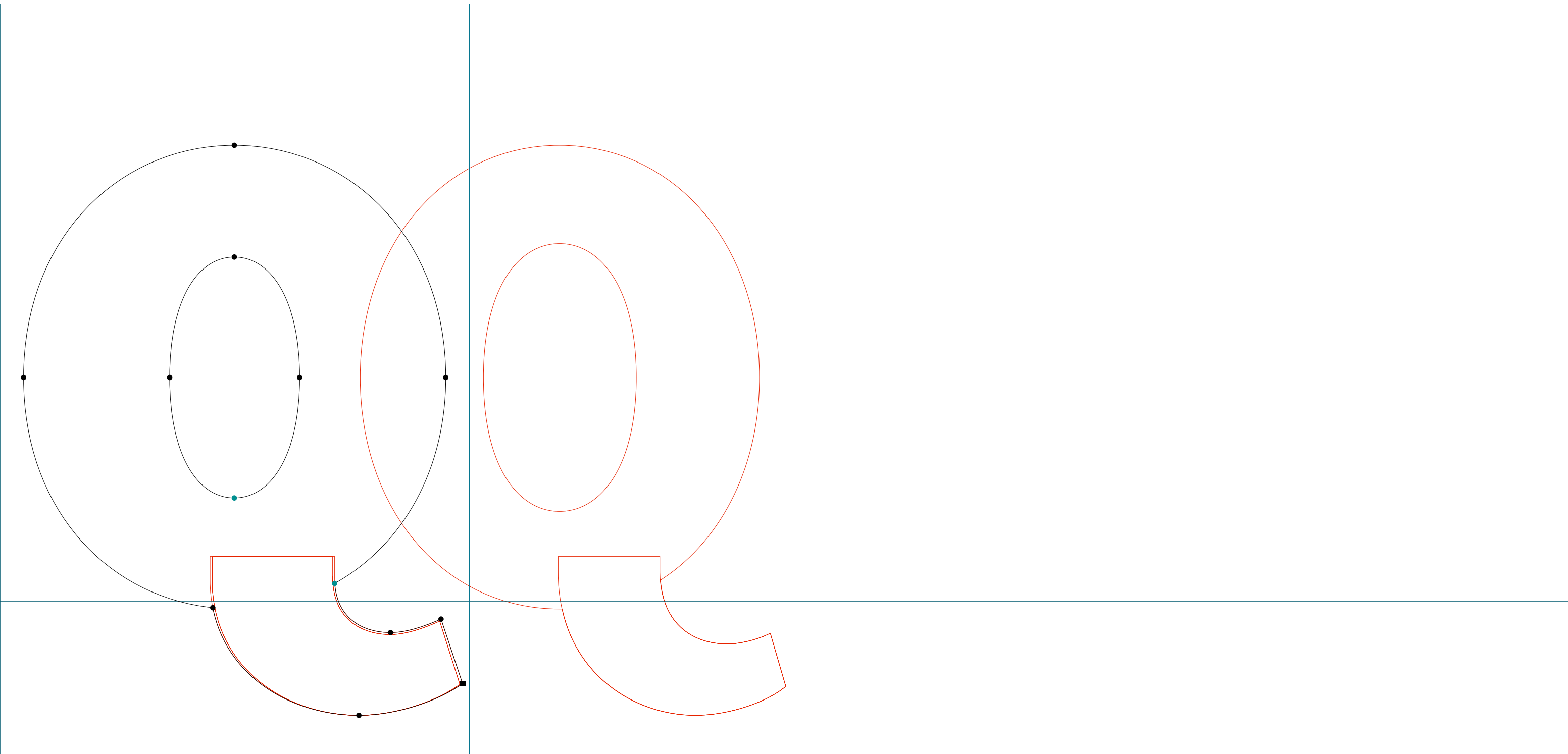

BASE 900

Base900Sans H | Y | RoboFog Sketches | 2010 | Emigre Fonts

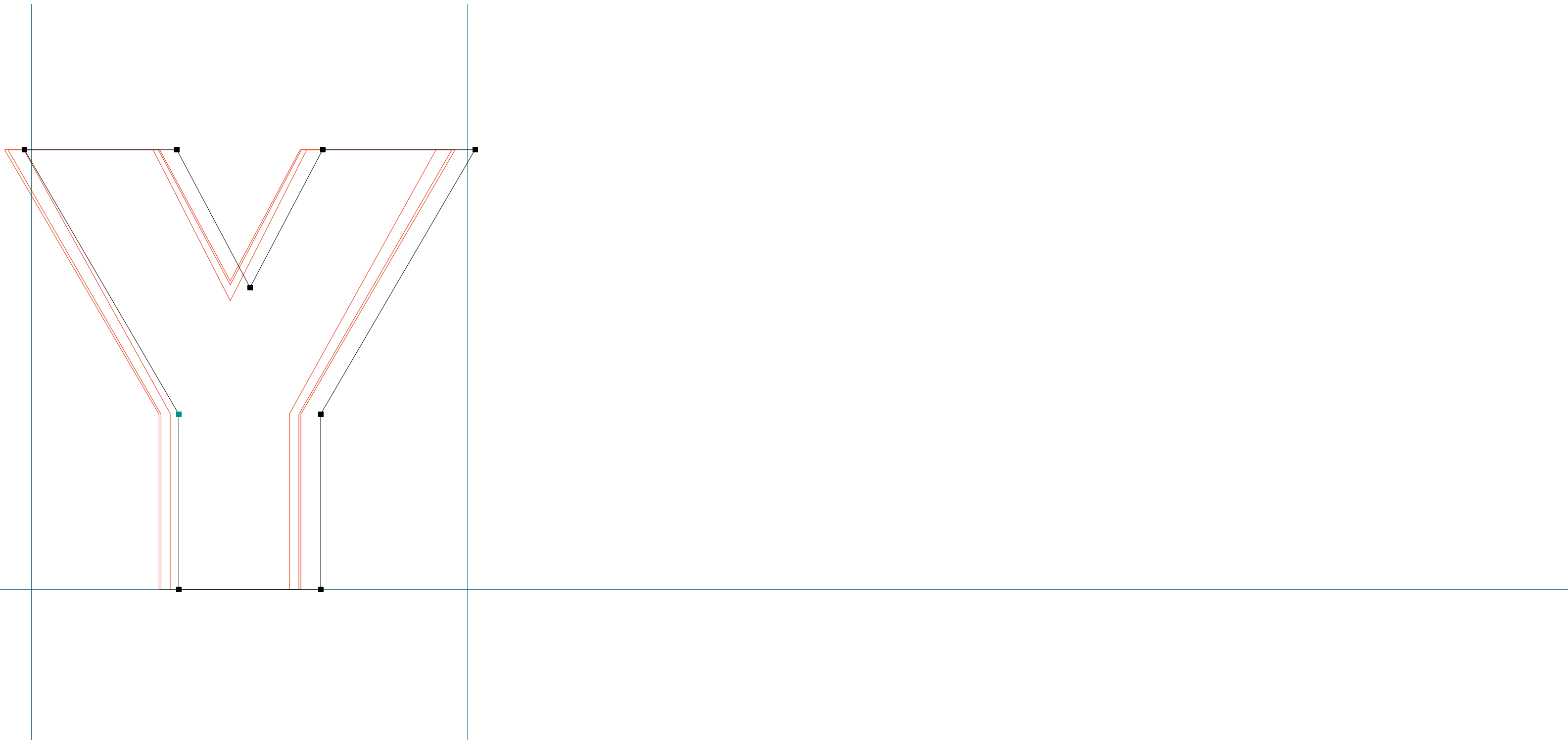

BASE 900

Base900Sans H | cent | RoboFog Sketches | 2010 | Emigre Fonts

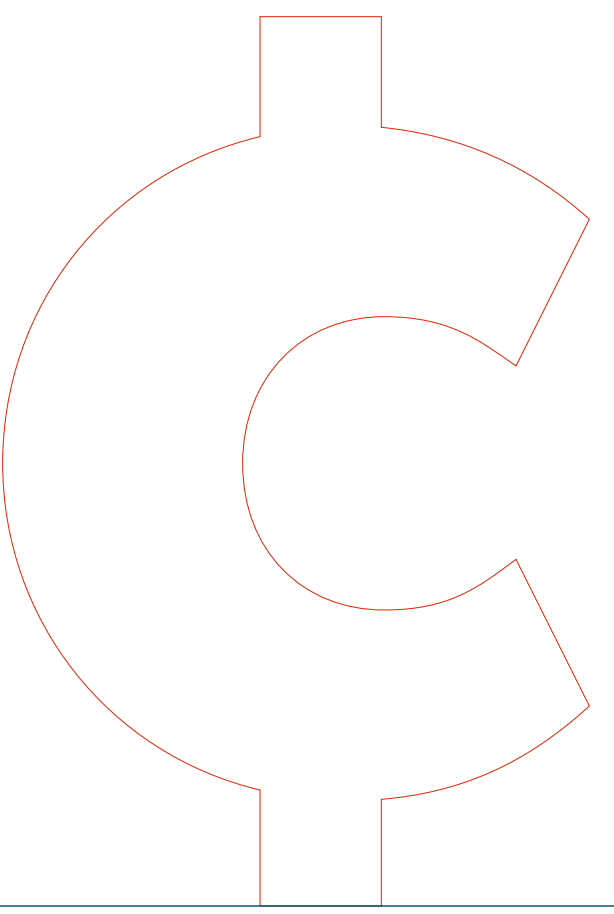
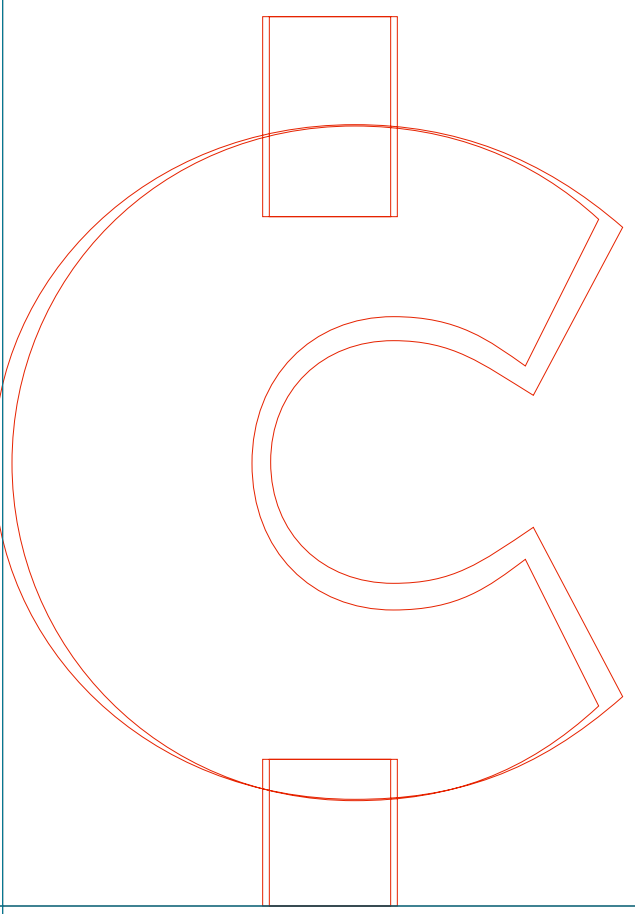
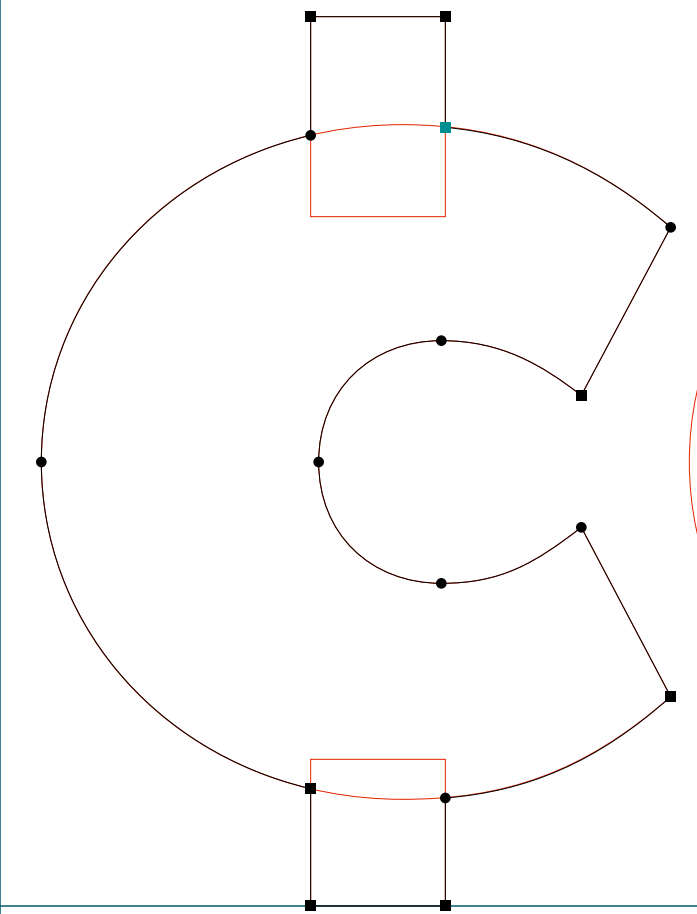

BASE 900

.....
Base900Sans H | currency | RoboFog Sketches | 2010 | Emigre Fonts

